



GYMNOVA

A PASSION FOR GYMNASTICS



GYMNOVA is a partner of the following federations:



International
Gymnastics
Federation



European Union
of Gymnastics



Quebec
Federation



Scottish
Federation



Canadian
Federation



French
Gymnastics
Federation



British
Gymnastics
Federation



Spanish
Federation



FLOORS

7

Artistic gymnastics	8
Rhythmic gymnastics	14
Aerobic	16



APPARATUS

17

Asymmetric bars	18
Beams	24
Vault	30
Springboards	39
Pommel horses	42
Rings	46
Parallel bars	52
High bars	58
Mini-apparatus	62



MATS

63

Landing mat layouts	64
Landing mats	66
Additional landing mats	67
Safety mats	68
Landing blocks	70
Mats for school	72
Tumbling tracks	73



LANDING PITS

75

Suspended sunken pit	76
Full built-in pit	77
Raised pit with integrated platform	77
Raised pit	78
Sunken pit with foam cubes	79
Combined pit	79
Inflatable pit	80
"Giant swing" pit	80



ACROBATIC SPORTS

81

Large competition trampolines	82
Built-in trampolines	84
Training trampolines	85
Trampettes	86
Long trampolines	88
Acrobatic tracks	89
Tumbling	92



INFLATABLE RANGE

93

Inflatable floor	94
Inflatable tracks	95
Inflatable mats	96
Inflatable inclined modules	97
Inflatable modules	98



LEARNING AND PHYSICAL TRAINING

99

Bases and Learning roller	100
Wall bars and Accessories	101
Ballet barres	102
Rebounders and Rope rails	103
Trampo-tremp and Vault	
"push-off" pads	104
Rockin'Gym and Rockin'Roller	105
Gym Kub and Multi-shape module	106



EDUC'GYM

107

Foam modules	108
Foam modules adapted	111
Wooden range	112
Learning mats	114



MISCELLANEOUS EQUIPMENT

115

Belts and Lanyards	116
Spotting rig	117
Access to the apparatus and Spotting	118
Chalk	119
Scoreboard	119
Miscellaneous	120
Protections	121

GYMNOVA DISTRIBUTORS	4
QUALITY AND ENVIRONMENT	5
PRODUCTION	6
PODIUMS	122
GYMNOVA RESEARCH CENTRE	124
GYMNOVA SERVICES	125
INDEX	127



GYMNOVA is an international company. Our products are distributed throughout the world, via our distributor network and our subsidiaries.

The reputation which GYMNOVA has earned for the quality of the new products it develops has enabled it to rise rapidly to the top of the worldwide gymnastics equipment market.

GYMNOVA means:

- Nearly 40 years' know-how and experience.
- Working closely with coaches and gymnasts.
- An untiring passion for the discipline

List of GYMNOVA distributors:

Algeria, Angola, Argentina, Australia, Austria, Belarus, Belgium, Bolivia, Brazil, Canada, Chile, China, Colombia, Costa Rica, Croatia, Cuba, Cyprus, Czech Republic, Denmark, Dominican Republic, Ecuador, Egypt, Finland, France, Germany, Greece, Guatemala, Honduras, Hong Kong, Hungary, Iceland, India, Iran, Ireland, Israel, Italy, Japan, Jordan, Luxembourg, Korea, Malta, Mexico, Morocco, Netherlands, New Zealand, Nicaragua, Norway, Oman, Panama, Paraguay, Peru, Poland, Portugal, Puerto Rico, Rumania, Russia, Salvador, Saudi Arabia, Singapor, Slovakia, Slovenia, South Africa, South Korea, Spain, Suriman, Sweden, Switzerland, Taiwan, Thailand, Tunisia, Turkey, Ukraine, United Arab Emirates, United Kingdom, Uruguay, USA, Venezuela, Vietnam.

QUALITY and ENVIRONMENT

GYMNOVA has been ISO 9001 (quality management) certified since 2001 placing customer satisfaction as our main focus of interest.

Since 2010, GYMNOVA has implemented an environmental management system as part of its quality management system. The focus, to reduce environmental impact, was rewarded in 2012 by the award of an ISO 14001.

As part of our continuous improvement policy our attention is concentrated on the following areas:

R&D, with the improvement of product design

Our eco-design process enables us to carry out life cycle assessments of products. We are therefore able to make design choices that show respect for the environment. Selective sorting of raw material offcuts and waste is practiced throughout the R&D process.

Logistics, with the limitation of greenhouse gas emissions related to transportation

At the product delivery stage our service providers are committed to steps to limit CO2 emissions.

They are taking action in the following areas:

- Improving their vehicle fleet
- Fuel savings
- Eco-driving
- Organising transport flows

In-house our production plants promote order consolidation on a daily basis in order to reduce CO2 generation.

Equipment installation

For equipment installation and packaging we aim to reduce the impact on the environment. Our products are packaged in materials that are 100% recyclable. When orders are prepared, the hire of a container is scheduled to take the waste (especially foam waste) from the forthcoming installation site. We rely on specialist companies that comply with current environmental regulations. For gluing polyurethane foam parts, we are developing the use of water-based adhesives, which are solvent-free and non-polluting.

GYMNOVA has not restricted its action to the head office only. Indeed, our production sites are also ISO 14001 certified. They recover waste to the maximum possible and the output from recycling is fed back into the production cycle. Our production plants carry out selective sorting and are seeking out new recycling channels. GYMNOVA is involved in sustainable development. A partnership with the "Ateliers Sans Frontières" association consists of recovering unused or damaged gymnastics equipment and refurbishing it giving this equipment a second life before it is sent to developing countries.

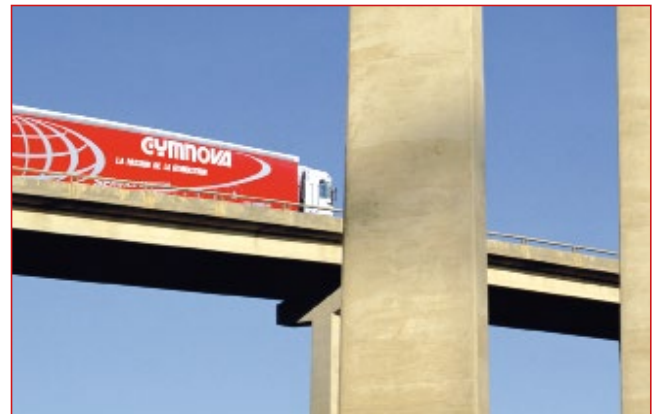

Papier recyclé

This catalogue has been printed on recycled paper in order to reduce environmental impact.

PRODUCTION



Manufacturing gymnastics equipment requires the know-how of several skills, which is why GYMNOVA, a gymnastics and sports equipment specialist relies on two factories for the production of its product ranges:

- Vieux d'Izenave (Rhône-Alps region): a 12,000 m² manufacturing facility producing equipment and gymnastic matting.
- Wattrelos in the north of France: a 4,500 m² facility dedicated to the manufacture of various types of matting and our Educ'Gym educational soft play equipment.

These production sites are committed to protect the environment and are both certified ISO 14001.





FLOORS





NEW

"MONTREAL" SPRING EXERCISE FLOORS WITH OVERLAY CARPET



New competition model provides more comfort and performance thanks to new components that make it versatile enough for all practice levels. Scientifically designed, this innovative exercise floor is the result of extensive research and development to satisfy and accommodate the performance needs of today's elite gymnasts.

These new spring exercise floors has been used at the 2017 World Championships in Montreal.

REF.	DIMENSIONS	SPECIFICITIES	FIG
6775	14 x 14 m	Springs assembled	
6775/DE	14 x 14 m	Springs not assembled	
6777	13 x 13 m	Springs assembled	
6777/DE	13 x 13 m	Springs not assembled	

NOTE: only complete exercise floors (carpet, foam and floor) can claim FIG approval. Dim. = 14 x 14 m (floor, foam and carpet). Thickness = 20 cm (identical height to GYMNOVA mats and pits).

We can custom make all types and sizes of exercise floors to suit your requirements. Please contact us for details.



ARTISTIC GYMNASTICS

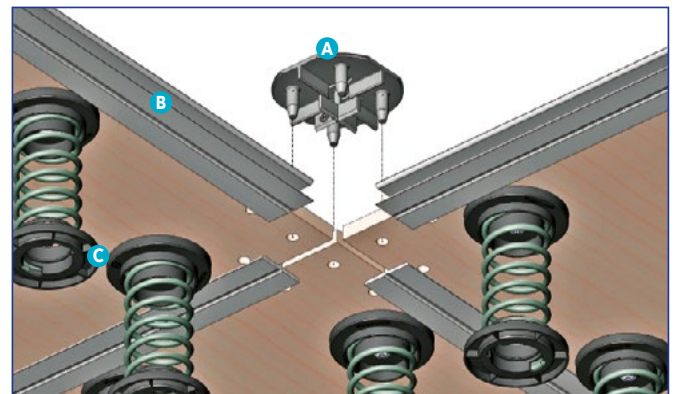
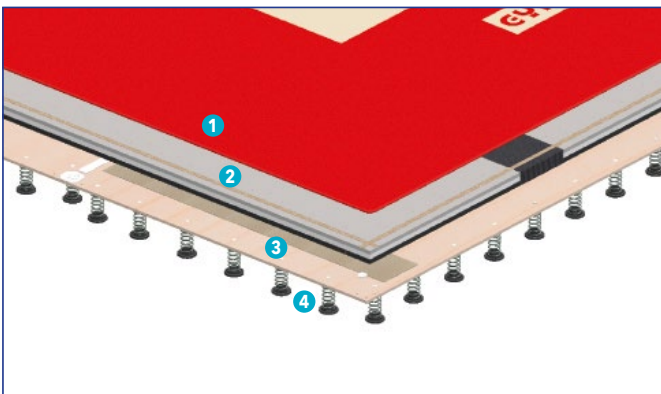

A/ Locking plate - B/ Fastening section - C/ Springs

Composition:

1 Overlay carpet

Made up of several widths joined together by hook-and-loop strips underneath the carpet. Integral edging in a different color. Perimeter of the carpet finished with whip stitching. Built-in anti-rotation system. Performance area = 12 x 12 m.

2 Concertina-folding comfort foam

New 56 mm thick laminated foam comprising 3 different hardnesses, including an ultra-soft 16 mm comfort layer providing dynamism, stability and comfortable landings. The foam area is made up of concertina-folding mats for quick and easy installation with pre-cut strips around the perimeter providing a perfect finish.

3 Floor

Special plywood laid on new dynamic springs. The panels are connected together using new fastening sections (B) and new locking plates (A) for optimum consistency.

4 Springs

2,709 more flexible springs with a height of 125 mm are strategically positioned on the floor for more consistent rebound. This increases the compression range of the springs, enabling the gymnast to obtain more travel.

Finish with PVC skirts.

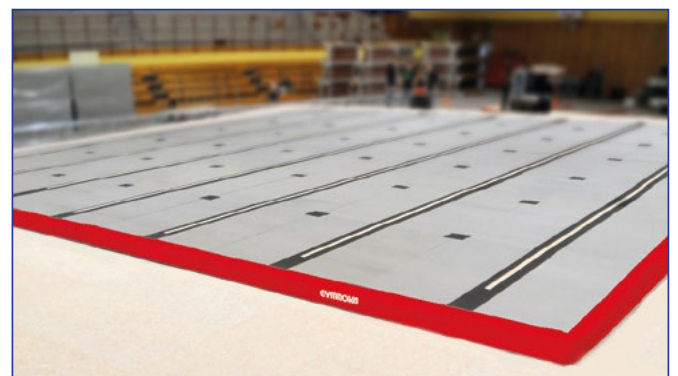

CARPET ONLY

12 x 12 m performance area marked out. Supplied with anti-rotation mechanism.

Ref. 6380 - Dim. = 14 x 14 m.

Ref. 6390 - Dim. = 13.05 x 13.05 m.

SPRUNG FLOORS ONLY (springs assembled)

Ref. 6785 - Dim. = 14 x 14 m. Thickness = 14 cm.

Ref. 6781 - Dim. = 13.05 x 13.05 m. Thickness = 14 cm.



"GLASGOW" COMPETITION SPRING EXERCISE FLOORS WITH ROLL-UP TRACKS

These floors consist of 7 roll-up tracks, puzzle shape foam plates and a sprung floor mounted on over 2,000 springs. Comfort is ensured by the 25 mm-thick roll-up tracks with a "Jaspe" (flame-pattern) carpet on high-performance dynamic foam.

The tracks are joined together by hook-and-loop strips. A 50 mm thick layer of high-density "puzzle" foam provides comfort and absorbs impacts. Quick and easy to assemble and dismantle (no tools needed) thanks to the GYMNOVA assembly system.

Technical features:

- Including 3 anti-rotation mechanisms (floor, foam, tracks).
- Edges are finished with PVC skirts.
- 12 x 12 m performance area marked out by 5 cm hook-and-loop strips.
- Thickness = 20 cm (identical height to GYMNOVA mats and pits).

REF.	DIMENSIONS	SPECIFICITIES	FIG
6576	14 x 14 m	Springs assembled	
6576/DE	14 x 14 m	Springs not assembled	
6578	13 x 13 m	Springs assembled	
6578/DE	13 x 13 m	Springs not assembled	

NOTE: only complete exercise floors (carpet, foam and floor) can claim FIG approval.

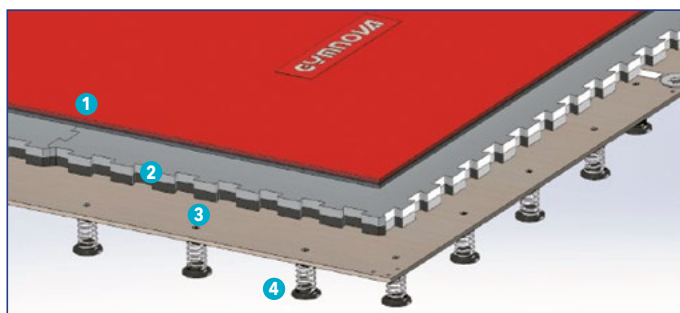

1/ Roll-up tracks - 2/ Puzzle shape foam plates
3/ Sprung floor panels - 4/ Springs

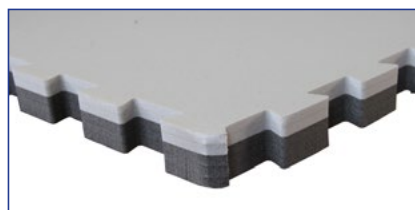

Foam plates

We can custom make all types and sizes of exercise floors to suit your requirements. The Montreal version is also available, please contact us for more information.



ARTISTIC GYMNASTICS



"LONDON" COMPETITION EXERCISE FLOORS WITH OVERLAY CARPET

These exercise floors comprise a two-tone gymnastics carpet, 4 cm thick foam and a 10 m thick high elasticity floor, featuring dynamic foam blocks.

The panels are connected together using fastening sections and locking plates for optimum consistency. The foam area is made up of several widths laid on the floor and joined by hook-and-loop widths. Each width features a concertina-folding system for quick and easy installation.

The overlay carpet, also made up of several widths, is joined together by hook-and-loop strips underneath the carpet for a completely flat and consistent working surface. The perimeter of the carpet is finished with whip stitching. Integrated anti-rotation mechanism.

Overall thickness = 14.50 cm.

Ref. 6570 "London" 14 x 14 m competition exercise floor

Floor = 13 x 13 m. Foam = 13.50 x 13.50 m.
Carpet = 14 x 14 m.



Ref. 6565 13.05 x 13.05 m training exercise floor

Floor = 12.50 x 12.50 m. Foam = 12.60 x 12.60 m.
Carpet = 13.05 x 13.05 m.

OVERLAY CARPETS ONLY

12 x 12 m performance area marked out.
Supplied with anti-rotation mechanism.

Ref. 6380 - Dim. = 14 x 14 m.

Ref. 6390 - Dim. = 13.05 x 13.05 m.

SPRUNG FLOORS ONLY

Ref. 6580 - Dim. = 13 x 13 m. Thickness = 10 cm.

Ref. 6595 - Dim. = 12.50 x 12.50 m. Thickness = 10 cm.

We can custom make all types and sizes of exercise floors to suit your requirements. Please contact us for details.

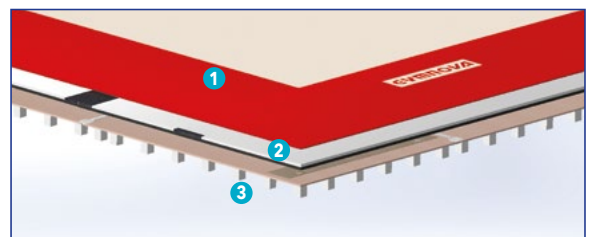

1/ Overlay carpet - 2/ Concertina-folding comfort foam
3/ Dynamic foam blocks

ARTISTIC GYMNASTICS



14 x 14 m EXERCISE FLOOR "ROLL-UP TRACKS"

Ref. 6574 - This entry-level model, ideal for training, comprises sprung floor Ref. 6580 (see page 11) and 7 40 mm thick roll-up foam/'flame pattern' carpet sections Ref. 6160 (see page 74) joined together with hook-and-loop strips. 12 x 12 m limit line marked out with 5 cm hook-and-loop strips. Supplied with anti-rotation mechanisms. Thickness = 14 cm (10 cm floor + 4 cm track).

We can custom make all types and sizes of exercise floors to suit your requirements. Please contact us for details.

14 x 14 m EXERCISE FLOOR "ROLL-UP TRACKS" ONLY

Ref. 6573 - Made up of 7 tracks Ref. 6160 fastened together by hook-and-loop strips. Foam covered in "Jaspe" carpet. Thickness = 4 cm.



Floor and roll-up tracks detail view

ROLL-UP TRACK and "EASY-ROLL" (see complete description on page 74)

Ref. 6160



Ref. 6165



TRACKS and ACCESSORIES

DIAGONAL MAT

Ref. 7004 - Allows gymnasts to replicate the angle of the competition floor when practising diagonal movements whilst increasing safety and comfort when landing.

The visual guide enables the mat to be positioned correctly and be always aligned with the diagonal sought by gymnasts.

Non-slip base, shock-absorbent polyurethane foam, removable cover, two-tone "leather-look" top.

Dim. = 200 x 200 x 10 cm.

Thanks to its hook-and-loop bib, an additional mat can be attached (Ref. 7005) to extend the landing area.



TRANSPORT TROLLEY

Ref. 6070 - Transport trolley for all GYMNOVA exercise floors. 4 omnidirectional pivoting castors with brake.

Dim. = 153 x 95 x 100 cm (Lxwxh).

Maximum working load = 380 kg.

NOTE: to store an exercise floor Ref. 6775, you need: 8 trolleys for the dynamic floor, 2 trolleys for the carpet, and 2 trolleys Ref. 6060 for the dynamic foam.



OVERLAY TARPULIN IN SMOOTH PVC

Provide excellent protection for floor or mats which are subject to intensive use.

Size made to measure; please contact us.

Ref. 6370 - Tarpaulin with hold-down system with eyelets cords. Requires a peripheral frame (not included).

Supplied with two-tone beige/red edging. Dim. = 12.30 x 12.30 m.

Ref. 6372 - Tarpaulin without hold-down system, two-tone beige/red. Dim. = 14 x 14 m.

Discover our inflatable floor on page 94

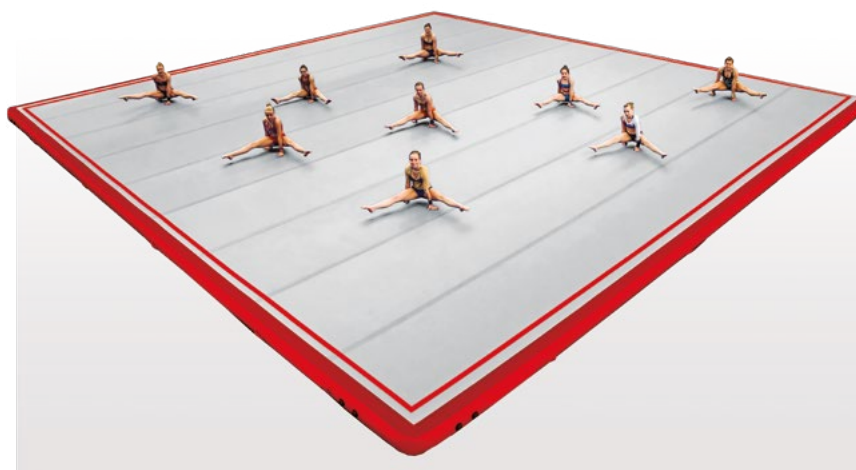



COMPLETE RHYTHMIC GYMNASTICS COMPETITION FLOORS

These Rhythmic Gymnastics competition floors has been used at many major events. They offer the gymnast an efficient, dynamic, smooth and even performance area. Installation is quick and simple and the contrasting 13 x 13 m performance area is clearly marked allowing for easy orientation during routines.

Ref. 6667 "London" complete rhythmic gymnastics competition floor

Made up of a RG floor base Ref. 6665 (Dim. = 13.50 x 13.50 m. Thickness = 40 mm) and a RG carpet Ref. 6655 (Dim. = 14 x 14 m (3 strips of 14 x 4 m and 1 strip of 14 x 2 m)).

Ref. 6668 "Evolution" complete rhythmic gymnastics competition floor

Identical to Ref. 6667 but supplied with a comfort layer (Ref. 6660) providing excellent shock absorption for the ankles and wrists, minimizing the risk of injury during performance and training thanks to the new comfort layer. Composed of 7 rolls of 2 m wide joined by adhesive (Density = 28 kg/m³. Thickness = 8 mm).

"London" competition floor has been used for the 2016 (Rio) and 2012 (London) Olympic Games, World Championships in Kiev (Ukraine) and Montpellier (France), European Championships in Guadalajara (Spain), University Games, Panamerican Games...

Only complete exercise floors can claim FIG approval.

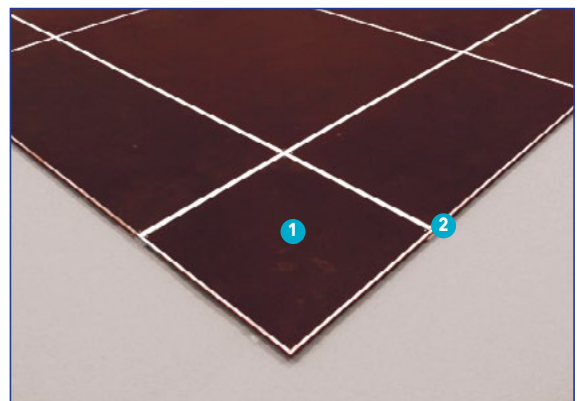

1/ Machined plywood plate - 2/ Fastening section

CARPETS and ACCESSORIES



RG CARPETS - COMPETITION

Finished with whip stitching.



Ref. 6655 - Dim. = 14 x 14 m.

Composition: 3 strips of 14 x 4 m and 1 strip of 14 x 2 m.
13 x 13 m performance area limit line marked out in 5 cm wide self-adhesive tape.

Ref. 6656 - Identical to Ref. 6655 but supplied with hook-and-loop joining strips, which are fixed under the carpet in order to avoid any gaps.

CARPET REEL TROLLEYS

Designed for rolling up, transporting and storing RG or artistic gymnastics exercise floor carpets.
Omnidirectional castors.

NOTE: one whole RG carpet will require the following equipment:
3 x Ref. 6670 + 1 x Ref. 6672.

Ref. 6669 - 5 m reel.

Ref. 6670 - 4 m reel.

Ref. 6672 - 2 m reel.

RG FLOOR BASE ONLY

Ref. 6665 - Dim. = 13.50 x 13.50 m (Lxw).

Composition: plywood (thickness = 12 mm) and dynamic foam (thickness = 28 mm).

RG CARPET - CLUB

Ref. 6657 - Carpet particularly suitable for training, easy and quick to install. The 13 x 13 m delimitation area is made by 5 cm wide adhesive tape.

Composition: 3 strips of 14 x 4 m and 1 strip of 14 x 2 m.
Dim. = 14 x 14 m (Lxw).





"CANCUN" COMPETITION AEROBIC FLOOR



Ref. 6632 - The design of the wooden panels provides a high-performance and dynamic exercise surface while maintaining consistency of the gymnastics area. The tension system using cables ensures the entire assembly is held together securely. Dedicated foam mounts located under the wooden panels provide excellent impact absorption thereby enabling injuries to joints to be reduced. The markings for the 7 x 7 and 10 x 10 m (by 5 cm wide self-adhesive tape) peripheral exercise zones enable the gymnastics area to be visualised exactly. Quick and easy set-up. Dim. = 12 x 12 m. Thickness = 7 cm. Matt varnish complies with FIG standards.

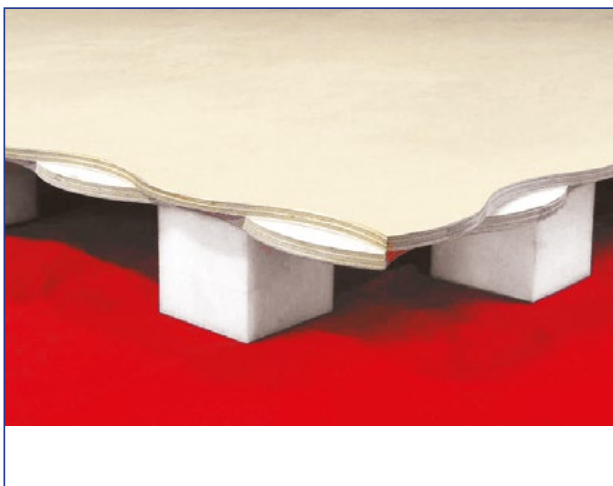

Waved-edge panels.





APPARATUS

ASYMMETRIC BARS



"RIO" COMPETITION ASYMMETRIC BARS

New competition asymmetric bars, compliant with FIG standards, have been developed with innovation both in design and in terms of mechanical characteristics. Completely revamped with new high quality components, the new "Rio" asymmetric bars are available in several versions with 3 different types of hand-rail to suit all gymnasts (see table opposite).

Designed for easy adjustment of hand-rail height and spacing without the need to alter cable length (adjusts via sliding tubes, ratchets and thumb wheels). Rapid tensioners allow the cables to be assembled and dismantled easily, as well as adjusting their tension.

The low hand-rail can be removed and the high hand-rail can be replaced by a high bar hand-rail for teaching purposes with straps for GAF use.

For easy adjustment of our cables and to maintain tension, all of our cabled asymmetric bars are equipped with a single-cable system fitted to the low bar.

Technical features:

- New graduated width adjusters and uprights with easily identifiable marking for precise FIG positions.
- Low hand-rail adjustable from 1.60 to 1.90 m (in 5 cm increments).
- High hand-rail adjustable from 2.45 to 2.75 m (in 5 cm increments).
- Instant hand-rails adjustment from 1.20 to 2.09 m using graduated spreader. Possible adjustment from 1.02 to 2.22 m.

These asymmetric bars equip the greatest gymnastics events including the Olympic Games (Rio, 2016), the World Championships (Montreal, 2017) and the European Championships (2018).

ASYMMETRIC BARS

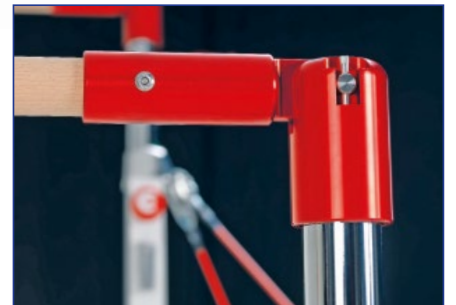
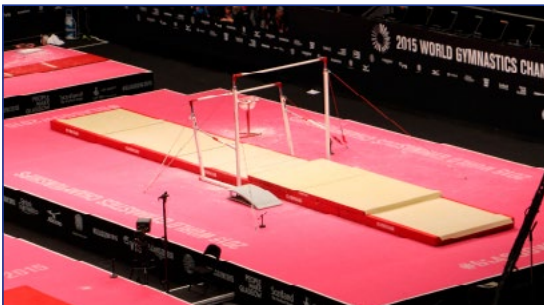

Completely revamped with new high quality components, the new "Rio" asymmetric bars come in several versions with 3 different types of hand-rail to suit all gymnasts and both standard and short cable systems.

REF.	CABLE	HAND-RAIL	FIG	FLOOR SPACE
3220	Standard	"Dynamic" wooden hand-rail Ref. 3262		5.50 x 4 m
3225	Short	"Dynamic" wooden hand-rail Ref. 3262		4 x 2.10 m
3230	Standard	Standard wooden hand-rail Ref. 3260		5.50 x 4 m
3235	Short	Standard wooden hand-rail Ref. 3260		4 x 2.10 m
3240	Standard	Natural fibre hand-rail Ref. 3265		5.50 x 4 m NEW
3245	Short	Natural fibre hand-rail Ref. 3265		4 x 2.10 m NEW

ASYMMETRIC BARS



TRAINING ASYMMETRIC BARS

Identical design to competition asymmetric bars (see page 18-19) but with shorter uprights providing better range to cater for smaller builds. Easy adjustment of hand-rail height and spacing without changing cable settings. Fibreglass hand-rail Ref. 3260 with a wood veneer.

Technical features:

- Low hand-rail adjustable from 1.40 to 1.70 m.
- High hand-rail adjustable from 2.15 to 2.45 m.
- Hand-rails spacing adjustment using graduated spreader from 0.76 to 1.98 m.
- Composite material rotating caps.
- Non-slip pads ensure full stability.

Ref. 3270

Training asymmetric bars with standard cable

Floor space = 5.50 x 4 m.

Ref. 3275

Training asymmetric bars with short cable

Floor space = 4 x 2.10 m.



Use of asymmetric bars Ref. 3275 on pit.

ASYMMETRIC BARS



"COMPACT" ASYMMETRIC BARS

Available in several versions, these asymmetric bars are ideal for those who need to set up and take down the equipment at each session.
 Height adjustment by sliding tubes with ratchets and thumb wheels.
 Fibreglass hand-rail Ref. 3260 with a wood veneer.
 Available with or without the folding mat Ref. 7080.

Technical features:

- Low hand-rail adjustable from 1.40 to 1.70 m.
- High hand-rail adjustable from 2.15 to 2.45 m.
- Hand-rails spacing adjustment using graduated spreader from 0.56 to 1.40 m.
- Bar width can be increased up to 1.55 m by changing the position of the diagonal strut on the upper upright.
- Floor space (without trolley): 2.62 x 2.01 m.

REF.	FEET	TRANSPORT TROLLEYS	FOLDING MAT REF. 7080
3355	Fixed	no	no
3357	Fixed	yes	yes
3345	Folding	yes	no
3347	Folding	yes	yes

Asymmetric bars with folding feet allow the reduction of the overall storage space needed.
 Dim. folded = 2.62 x 0.90 m (Lxw).



NOTE: possible to add cable system Ref. 3292, optional. Optional central mat Ref. 3855 (see page 23).

CUSTOM FOLDING MAT

Ref. 7080 - Custom folding mat (fits on your existing GYMNOVA freestanding asymmetric bars).
 21 kg density polyurethane foam covered in class M2 fire rating "leather look" PVC cover.
 Fitted with hook-and-loop strips at both ends. Clearance cut-out allows the mat to fit perfectly around the apparatus feet to give a perfectly flat surface.
 Overall dim. = 430 x 260 x 20 cm (Lxwxth).

NOTE: using mats requires the bars to be fitted with the transport trolley Ref. 3850.

ASYMMETRIC BARS

WOODEN HAND-RAILS

For all our asymmetric bars, can also be used with our high bars. Round fibreglass hand-rails with a wood veneer. Ø = 40 mm. Unit.

 **Ref. 3260 "Standard" hand-rail**

 **Ref. 3262 "Dynamic" hand-rail**
More rigid than hand-rail Ref. 3260, allowing increased dynamism and faster response time.

NATURAL FIBRE HAND-RAILS

Round fibreglass hand-rails covered with natural fibre. This material is more malleable and durable than wood. The covering is therefore more consistent, which increases its lifespan.

Its texture also allows gymnasts to get excellent grip with less bar preparation time. In use, less chalk is needed on these hand-rails. Unit.

 **Ref. 3265 Competition hand-rail - Ø 39.2 mm**
Compliant with FIG standard.
Colour: natural fibre.

Ref. 3268 Training hand-rail - Ø 37.5 mm
It has a reduced diameter, which allows smaller gymnasts to get a better grip, learn techniques and gain confidence before moving on to the competition bar.
Colour: pink. This colour makes the hand-rail easier to see when learning the first releases.

Compatible with all GYMNOVA asymmetric and high bars.



MINI ASYMMETRIC BARS

Ref. 0120 - Allow children to develop their first gymnastics movements and sequences. Removable and transportable, they are modular. Easy spacing adjustment between 0.25 and 1.30 m. Height adjustment:

- Low bar: between 0.90 and 1.40 m.
- High bar: between 1.40 and 1.90 m.

Technical features:

- Round fibreglass hand-rail, Ø = 3.50 cm.
- Space between uprights: 1.54 m (will accommodate 1.50 m mats, not supplied).
- Floor space: 1.77 x 1.71 m.
- Non-slip feet.

Discover all our mini apparatus on page 62.



ASYMMETRIC BARS



UPRIGHTS GUARDS

Asymmetric bars uprights guards. Complete set (2 tall and 2 short ones).

Ref. 2945 - For "Rio" competition bars (see page 19).

Ref. 2942 - For training bars Ref. 3270 and 3275.

CABLE GUARDS

Ref. 2925 Cable guards medium model

Length = 2 m. Set of 2.

Ref. 2926 Cable guards small model

Length = 1.20 m. Set of 2.

Ref. 2927 Cable guards large model

Length = 2.50 m. Set of 2.

Ref. 2929

For short cable asymmetric bars cables and tighteners. Complete set (4 average and 2 short ones).



TRANSPORT TROLLEYS

Ref. 3850 - Retractable and suitable for all our freestanding asymmetric and parallel bars. Featuring omnidirectional castors to be attached to the apparatus during assembly. Supplied with bars Ref. 3345, 3347 and 3357.

Discover access to the apparatus and spotting on page 118.



PROTECTIVE SLEEVES

For high and asymmetric bars hand-rails. Pair. Thickness = 2 cm. $\varnothing = 83$ mm.

Ref. 2900 - L = 59.5 cm.

Ref. 2905 - L = 35 cm.



CENTRAL BEVELLED UNDERLAY

Ref. 3855 - Designed for all our freestanding bars (parallel and asymmetric bars). With cut-outs to fit transport trolleys Ref. 3850. Dim. = 2.09 x 0.46 m. Thickness = 6 cm.

CABLE SYSTEMS

Ref. 3203 - Standard cable system for Ref. 3220, 3230, 3240 and 3270, for 5.50 x 4 m floor area (4 anchors required).

Ref. 3204 - Short cable system for Ref. 3225, 3235, 3245 and 3275. Reduces the floor space required by approx. 60%. Floor area 4 x 2.10 m (8 anchors required).

Ref. 3292 - Optional cable system for freestanding bars. Comprises of 2 cables which attach to high uprights. Provides excellent stability.

Easy to assemble/dismantle. Strongly recommended for larger builds. Only 2 special floor anchors required.



BEAMS



STANDARD LEGS BEAMS

These beams are 5 m long and 10 cm wide featuring a rigid reinforced aluminium body with a non-slip padded top surface. Equipped with a quick and easy adjustment for setting the height of the beams from 0.90 to 1.40 m. Positioning is done on a graduated scale. Supplied with non-slip pads. Transport trolleys (Ref. 3695) and protective pads (Ref. 2920) are optional.



Ref. 3610 - Standard legs beam with soft foam end caps.

Ref. 3611 - Standard legs beam with PVC end caps.



Guards for beam legs
Ref. 2920.



Height adjustment and
tightening with thumb wheel.



BEAMS



BEAM WITH ADJUSTABLE ELASTICITY BASE

Ref. 3620 - The body of this beam is identical to Ref. 3610. Thanks to its elasticity adjustable base, gymnasts can set the level of flex in the beam by choosing from 5 flexibility positions (position 5 being the most flexible).

Benefits of adjustable elasticity:

- Reduced risk of repetitive strain injuries by providing shock absorption for landings.
- It enables resilience to be adjusted to match the gymnast's weight.
- One end can be locked to obtain a springboard effect for dismounts.

In position 1 (the most rigid position), beam behaviour is equivalent to competition beam Ref. 3610.

Transport trolleys optional (Ref. 3695 or Ref. 3697, see page 29).

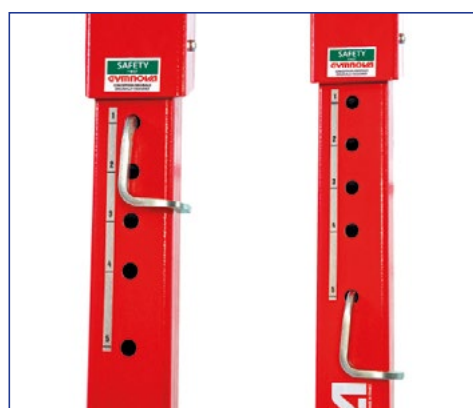

Rigid setting

Flexible setting

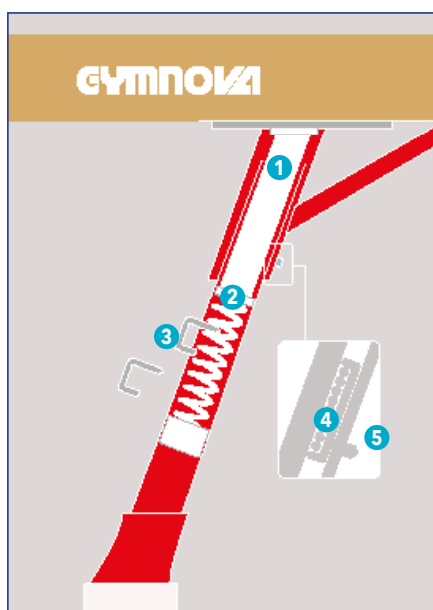

- 1 Retractable part
- 2 Return spring
- 3 Adjusting locking pin
- 4 Roller bearing
- 5 Play adjustment screw

BEAMS



"COMPACT" BEAM

Ref. 3612 - This traditional beam with 0.90 to 1.40 m height adjustment is useful for those who need to set up and take down the equipment at every session. This set of beam + custom folding mat has been developed to enable quick set-up and easy storage.

Composition:

- Beam with standard legs Ref. 3611 (see page 25).
- Transport trolleys Ref. 3695.
- Custom folding mat Ref. 7086.

"Mat + beam" may be purchased as a set or separately.

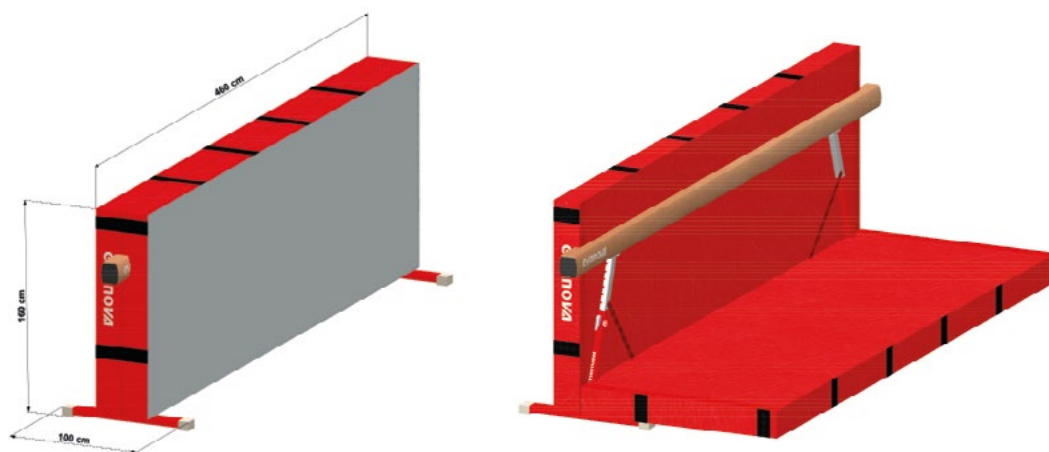

INTEGRATED MAT

Ref. 7086 - Folding integrated mat only. Only fits GYMNOVA beams with standard base. Transport trolleys Ref. 3695 are required. Overall dim. = 460 x 300 x 20 cm (Lxwxth).

Technical features:

Polyurethane foam with class M2 fire rating "leather look" PVC cover. Hook-and-loop strips at both ends (for attaching additional mats if required). Handles for holding upright (for transporting). Cut-outs allow it to mould to the shape of the apparatus feet in order to create a perfectly flat surface.

Compliant with European standard NF-EN 12503.

BEAMS



Ideal for initiation into and discovery of gymnastics, low beams enable work to be done on floor height components and reduce apprehensiveness.



LOW BEAMS

Identical beam body to Ref. 3611 but on a low base.
L = 5 m.



Ref. 3670 - Low beam - height = 20 cm.

Ref. 3672 - Low beam - height = 40 cm. Raised by 20 cm, it can be used with landing mats placed underneath.



FOAM LEARNING BEAM

Ref. 3665 - Beam cushioned and stable for training. Several identical beams can be joined together with a hook-and-loop strips system. PVC top with central alignment line.
Dim. = 250 x 24/15 x 8 cm (Lxwxh).



LEARNING BEAMS CARPET-COVERED

This wooden beam covered in carpet is fitted with toggle hooks for attaching to Educ'Gym bases or another identical beam.

Ref. 0041 - Dim. = 250 x 12 x 34 cm (Lxwxh).

Ref. 0043 - Dim. = 300 x 12 x 34 cm (Lxwxh).



DYNA'BEAM

Ref. 0312 - This light and dynamic foam-covered beam has non-slip underside and top identical to the beam body covering. Can be used with other components from Educ'Gym range thanks to hook-and-loop strips.
Dim. = 150 x 25/10 x 15 cm (Lxwxh).



MAXI DYNA'BEAM

Ref. 0335 - Thanks to its dimensions and a high-density quality foam, this mini beam is particularly stable.

With a surface identical to our standard competition beams, young gymnasts become familiar with its feel and texture. It can be combined with other components when creating baby-gym circuits using hook-and-loop strips.

Dim. = 150 x 24/15 x 8 cm (Lxwxh).

BEAMS



REMOVABLE BEAM COVER

Ref. 3652 - This cover is a practical way of extending the lifespan of your beam. Easy to install, it gives your beam a fresh lease of life by directly covering worn parts. It is compatible with different types of beam (GYMNOVA and other brands) and covers the beam body without having to remove the existing cover. The cover is identical to a standard beam body with stretch fabric end caps. L= 5 m. The cover attaches using hook-and-loop strips and PVC retaining rings, meaning fabric tension can be adjusted (to be fitted by the customer).



TRANSPORT TROLLEYS

Ref. 3695 - (Pair). Attach to standard feet with omnidirectional castors, which swing away when equipment is in use.

TRANSPORT CASTORS

Ref. 3697 - (Pair). Attached to one side of a single leg. A transport handle is attached to the other leg. The handle is used to lift the beam when transporting.



BEAM WIDENER

Ref. 3682 - Fits all GYMNOVA beam bodies and widens the bearing surface. Covering identical to standard beam body. The different foam densities have a touch marker indicating the width of a standard beam (10 cm). Length = 2.50 m. Width = 25 cm.



"U" BEAM WIDENER

Ref. 3664 - Foam widener with simple fastening system. Enables training to be carried out while reducing impact stress associated with repeated exercises and builds confidence by increasing the bearing surface width. Two wideners covering the entire beam. Recommended for beginners. Length = 2.50 m. Width = 25 cm.



BEAM PROTECTION PADS

Removable protection pads for beam bodies. Very easy to fit using hook-and-loop strips. Highly shock-absorbent foam. Thickness = 15 mm.

Ref. 3661 - Length = 1 m.

Ref. 3662 - Length = 2.50 m.

MULTI-PURPOSE "CARPETTE" MAT

Ref. 6016 - Multi-purpose mat, made from very soft and highly shock-absorbent foam, covered in stretch jersey and with a non-slip base. It is particularly well suited to use on a beam thanks to its ability to mould to the contour of the apparatus. Dim. = 150 x 100 cm. Thickness = 1.5 cm. See page 73.



PROTECTIONS

Ref. 2920 - Guards for "standard" vaulting table, horse and beam legs. Set of 2 guards.

Ref. 1398 - Cut-out guards specifically for beam legs. It is possible to add 2 m mats between them to protect the whole apparatus. Dim. = 94 x 25 x 20 cm (Lxwxh). Thickness = 20 cm. Pack of 4.





VAULTING TABLES

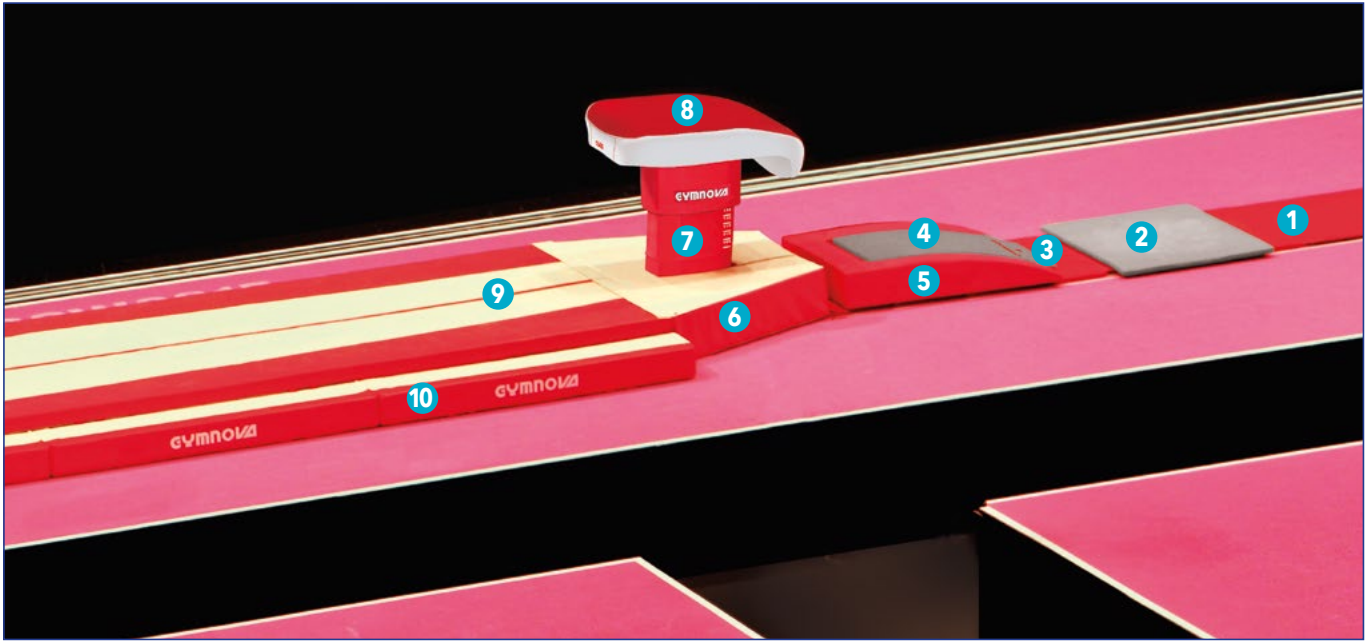

1 COMPETITION RUNWAY

Ref. 2106 - Made of a "flame pattern" carpet bonded to dynamic foam with non-slip base.
Dim. = 25 x 1 m. Thickness = 25 mm.

2 "ROUND-OFF" MAT

Ref. 2117 - Ideal for hand placement in Yurchenko vaults. Provides comfort to reduce strain injuries. Soft class M1 fire rating stretch fabric covering. Reversible mat. Official FIG dim. = 120 x 100 cm. Thickness = 3 cm.

3 RISER PANEL

Ref. 2753 - The size of this panel has been carefully calculated to ensure that there is no height difference between the runway and the vaulting table. Thickness = 25 mm.
Comprises:
• Panel = 3.10 x 1m.
• Extension panel = 1.30 x 1 m.

4 EVOLUTION SPRINGBOARDS

Ref. 2186 Competition springboard "Hard"
Ref. 2187 Competition springboard "Soft"
See description on page 39.

5 SPRINGBOARD GUARD

Ref. 2115 - Complete guarding of the springboard (1.20 m long) providing safety during Yurchenko vaults. Fits to all springboards. Non-slip base.

6 PEDESTAL BASE SURROUND

Ref. 2921 - (Pair). This guard has been designed to cover the entire metal vaulting table pedestal. Angled shape to enable gymnasts to exit easily in the event of a failed vault. Width runway side = 1 m. Width landing mats side = 2 m. Length = 1.20 m. Thickness = 30 cm. Attached by with hook-and-loop strips to the dismount mat Ref. 7006.

7 PEDESTAL GUARD

Ref. 3402 - Full guard for centre-base vaulting tables.

8 PEDESTAL-BASE VAULTING TABLE **NEW**

Ref. 3404 - (See description on page 33). FIG approved.

9 DISMOUNT MAT

Ref. 7006 - Top mat which is positioned over landing area to give gymnasts more safety and comfort.
Dim. = 600 x 200 x 10 cm (Lxwxth).
Compulsory in FIG competitions (see page 67).

10 VAULTING MAT LAYOUT

Ref. 1705 - Total area = 15.60 m² (see description on page 65).



GLASGOW 2015

VAULTING TABLES



NEW

"MONTREAL" PEDESTAL BASE VAULTING TABLE

Ref. 3404 - Vaulting table featuring a two-tone dynamic body with a soft front section for shock absorption and a non-slip top covering the hand placement area.

With a body using a combination of dynamic foam and springs, this new vaulting table gives gymnasts a fast, dynamic response.

It is very comfortable to use and reduces gymnasts' fear thanks to its reassuring shape and its comfort layer positioned over the whole hand placement area to soften impacts.

The new adjustment system makes it easy to adjust height with one operation without bending down. User safety is ensured by the pre-formed foam guard covering the whole vertical column (3-part protection).

Technical features:

- Height adjustment between 1 and 1.35 m without removing the guard with locking notches at 5 cm intervals.
- Quick height read-off thanks to the marker points on both sides of the pedestal guard.
- Supplied with pedestal guard (Ref. 3402) and fixing system to floor (without anchor points).



Quick height read-off thanks to marker points



Locking system



Close-up of springs giving a fast, dynamic response

VAULTING TABLES



NEW

TRAINING VAULTING TABLES

Standard legs vaulting tables equipped with a body which is identical to the FIG approved vaulting table. They are height-adjustable using a ratchet and thumb wheel. Supplied with a fixing system to floor (chain + adjustable tensioner). Transports trolleys Ref. 3695 and protective leg guards Ref. 2920 are optional.

Ref. 3455 Standard vaulting table

Height adjustment from 0.95 to 1.45 m.

Ref. 3453 Team'Gym vaulting table

Height adjustment from 1.30 to 1.65 m. Suited for Team'Gym practice.

SUB-ASSEMBLY

Ref. 3454 Table body only

Dynamic two-tone sprung body with a flexible front section for shock absorption and non-slip top for hand placement.

The vaulting table body is compatible with the various types of GYMNOVA vaulting table legs (for pedestal base and standard legs). Supplied with connection kit.

Ref. 3401 Complete pedestal base without guard

Ref. 3402 Full guard

NEW



VAULTING TABLES

PIT-EDGE VAULTING TABLES

Ref. 3403 - Pit-edge pedestal base only.

Ref. 3416 - Pedestal-base vaulting table with base guard and fixing system to floor. Identical to Ref. 3404 but floor-mounted. Ideal for pit landings.

Ref. 3428 - Folding "Evolution" pit-edge vaulting table. Ideal for multi-purpose halls, it makes the most of the space available around a pit. Height adjustment from 1.10 to 1.50 m. Supplied with foam guard (Ref. 2924) and floor anchors.



NEW

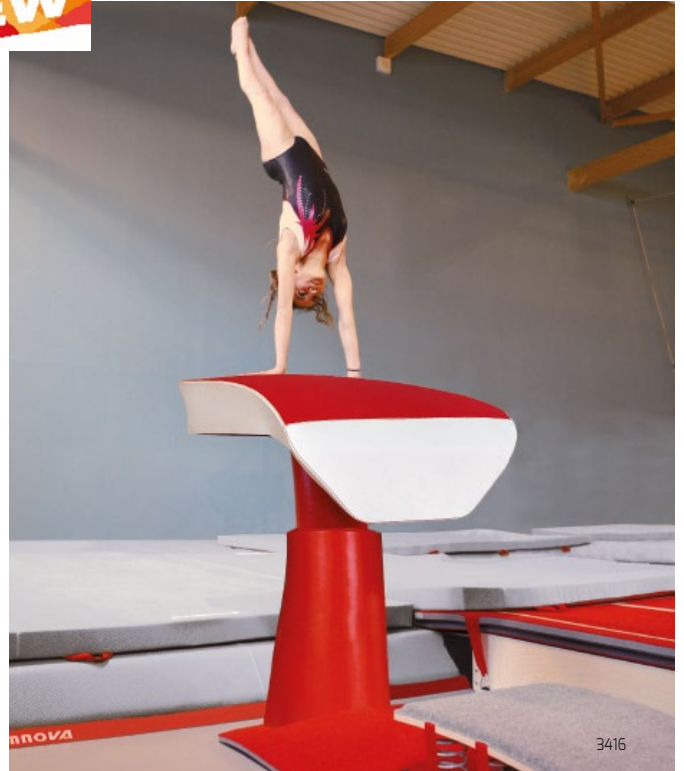

VAULTING TABLE BETWEEN TRAMPOLINE AND PIT

Ref. 3499 - Vaulting table between trampoline and pit.



VAULT "PUSH-OFF" PADS

Help with practice on second flight. Provide additional power to small builds. Reduce risk of wrist injury. Length = 90 cm.

Ref. 3495 - Can be used either on the ground or on a vaulting horse.

Ref. 3497 - Take-off is performed on the trampoline and landing in the pit. Side retractable, instantaneous locking and unlocking.

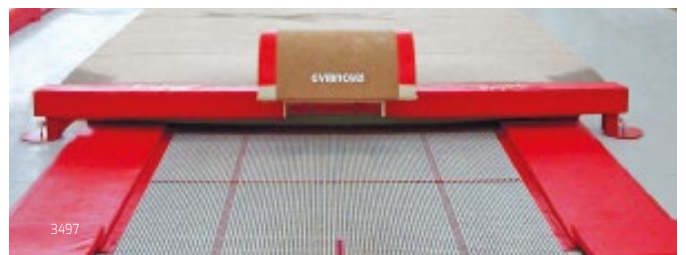

VAULTING TABLES



FOAM VAULTING TABLE

Ref. 3472 - This teaching tool conquers fear and adds confidence while learning the various jumps. Comprises 4 sections which can be stacked to create different heights and angles, including regulatory heights. Supplied with stabilising rails.

- Available heights at regulatory angles: 1.05 / 1.15 / 1.25 / 1.35 m.
- Heights at teaching angles: 0.85 / 0.95 / 1.05 / 1.15 m.
- Overall dim. = 135 x 95 cm (Lxw).

Comprising 4 stackable components:

- A** Top module: 95 x 85 cm (Lxh)
- B** Triangle module: 95 x 12/55 cm (Lxh)
- C** Rectangle module: 95 x 10 cm (Lxh)
- D** Rectangle module: 95 x 20 cm (Lxh)

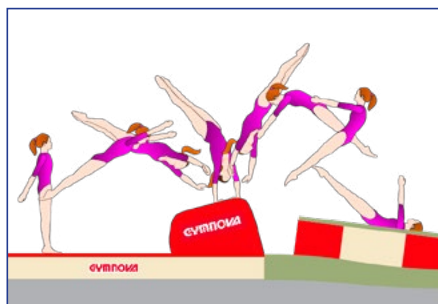
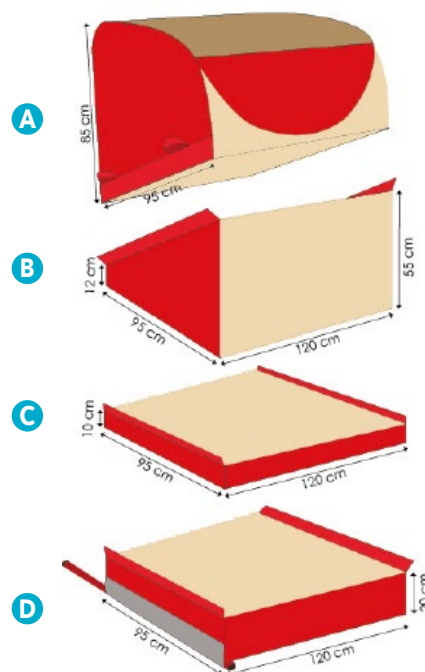

Learning handsprings with half twist



Learning the "Yurchenko"



Learning handsprings off the vault

FOAM VAULTING HORSES

Progressively builds up confidence in jumping over obstacles. The modular nature of the sections allows to build different types of obstacles. Modules can be taken apart and used separately. High density foam, non-slip base, carrying handles.

VARIO'HORSE

Ref. 0301 - Consists of the following elements:

- Base module: 150 x 80/50 x 70 cm (Lxwxh).
- Middle modules:
 - A** 120 x 50 x 20 cm (Lxwxh).
 - B** 90 x 50 x 20 cm (Lxwxh).
 - C** 60 x 50 x 20 cm (Lxwxh).
 - D** 30 x 50 x 20 cm (Lxwxh).
- Rounded module: 150 x 50 x 30 cm (Lxwxh).

Several possible heights: 70, 90, 100, 110, 120, 140 cm.
Overall dim. = 150 x 80/50 x 140 cm (Lxwxh).



LARGE FOAM VAULTING HORSE

Ref. 0275 - Consists of 4 elements:

- Base module: 160 x 100/58 x 85 cm (Lxwxh).
- Middle modules (2 units): 160 x 58 x 12 cm (Lxwxh).
- Rounded top module: 160 x 58 x 20 cm (Lxwxh).

Several possible heights: 85, 97, 105, 109, 117, 129 cm.
Overall dim. = 160 x 100/58 x 129 cm (Lxwxh).



LARGE TRAPEZIUM FOAM MODULE

Ref. 0261 - Foam box consists of 4 elements. The modular nature of the sections allows to build different types of obstacles. Each section is made from dual density foam, with a harder area on top for stability.

Carrying handles, non-slip base.

Several possible heights: 30, 60, 90 and 120 cm.
Height of each module: 30 cm.
Overall dim. = 120 x 90/40 x 120 cm (Lxwxh).

Module dimensions:

- A** 120 x 52.50/40 x 30 cm (Lxwxh).
- B** 120 x 65/52.50 x 30 cm (Lxwxh).
- C** 120 x 77.50/65 x 30 cm (Lxwxh).
- D** 120 x 90/77.50 x 30 cm (Lxwxh).



VAULTING HORSES and ACCESSORIES

Ideal for the introduction of vaulting, facility to use each section separately.



2510

EDUC'GYM BOX

Ref. 2510 - Consists of 3 Educ'Gym sections of a height of 33 cm. Padded removable cover section, stabilisers and transport trolleys.
Dim. = 160 x 40 x 100 cm (Lxwxh).



2500

WOODEN BOX

Ref. 2500 - Straight-sided solid wooden box. Consists of 5 elements. High density foam-padded top with synthetic cover, slots for attaching balance benches Educ'Gym Ref. 0045. Possible heights: 40, 60, 70, 80, 90 and 110 cm. Built-in carrying handles and transport trolleys. Dim.= 150 x 50 x 110 cm (Lxwxh). Dim. with feet = 150 x 80/45 x 110 cm (Lxwxh).

TRAINING RUNWAY

Ref. 2101 - Carpet-covered resilient foam on a non-slip base.
Dim. = 25 x 0.66 m. Thickness = 17 mm.



HOOK-AND-LOOP STRIPS

Ref. 2113 - For attaching measuring tape to runways.

MEASURING TAPE

Ref. 2112 - L = 30 m. Optional for above runways.

FREESTANDING BASE

Ref. 2752 - Allows to have a uniform approach surface (no height difference between the runway and the vaulting area). This base system is easy to fit and ideal for sports halls in which floor anchoring is not possible.

Specially designed for pedestal-base GYMNOVA vaulting tables. Base panels join together with hook-and-loop strips. Supplied with anchoring points.

Consists of 2 elements:

- Base (dim. = 3.10 x 1.50 m).
- Extension (dim. = 1.30 x 1 m. Thickness = 25 mm).

GUARDS

Ref. 2920 - Guards for "standard" type GYMNOVA table, horse and beam legs. Set of 2.

Ref. 2922 - For vaulting table and horse chains.

TRANSPORT TROLLEYS

Ref. 3408 - Optional transport trolley for vaulting table Ref. 3404.

Ref. 3695 - Transport trolleys for standard legs vaulting tables. Pair.



2929 + 2922



3408

SPRINGBOARDS

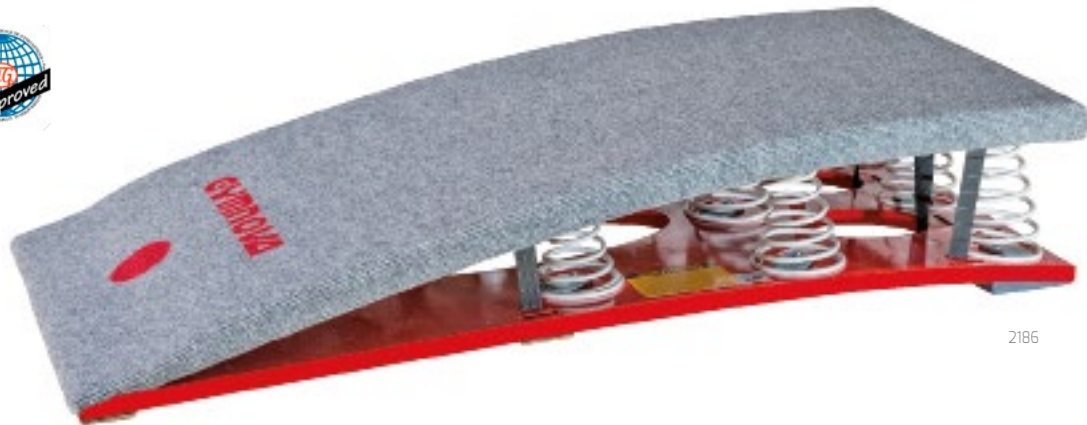

2186

COMPETITION SPRINGBOARDS

Designed for intensive use, these competition springboards allow exercises to be repeated while minimising premature gymnast fatigue. There is high elasticity across the whole working surface thanks to the positioning of the springs and the materials used including the fibreglass layer over the entire wooden board.

These springboards guarantee optimal comfort and stability on impact and enable virtually immediate energy return for gymnasts. Available in 2 models (Hard & Soft), male and female gymnasts can choose whichever best suits their physique and style.

Technical features:

- Standardised 120 x 60 cm size board in curved plywood and fibreglass covered in carpet.
- Height = 23 cm.
- Carrying handles incorporated in the frame.
- Non-slip pads.
- Conical steel springs.

EVOLUTION SPRINGBOARD "HARD"

Ref. 2186 - Aimed more at the larger build (50 -100 kg).
Distinguishing mark: red dot on the board. With 8 springs.
Weight = 25 kg.

EVOLUTION SPRINGBOARD "SOFT"

Ref. 2187 - Aimed more at the lighter build (40 -75 kg).
With 5 springs. Weight = 23 kg.



Dynamic board with carrying handles and non-slip pads

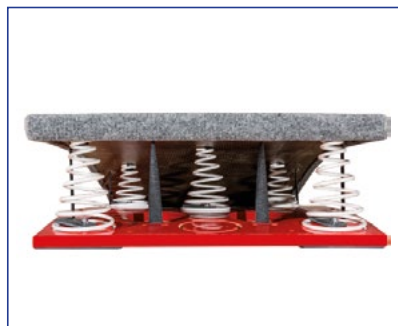

Conical steel springs



Evolution springboard "Soft" Ref. 2187

SPRINGBOARDS

COMMON FEATURES:

Springboards with castors (except Ref. 2196 and 2197, optional), non-slip pads, coil springs, standard 120 x 60 cm boards, in curved plywood with built-in reinforcement and cushioned carpet-covered top layer.



COMPETITION SPRINGBOARDS - 23 cm

Choice of 2 springboards to suit gymnast physique and style. Energy return from the whole usable surface area thanks to the last spring positioned at the bottom of the board. Board covered with 2.5 cm thick foam. Built-in carry handles.

Height = 23 cm. Weight = 24 kg.

Ref. 2196 Springboard Nova'Jump"Hard"

With 9 conical steel springs.

Ref. 2197 Springboard Nova'Jump"Soft"

With 7 conical steel springs.

DOUBLE SPRINGBOARD - 40 cm

Ref. 2130 - High elasticity, recommended for use instead of 2 springboards placed one on top of the other, to improve safety and performance.

With 2 soft cylindrical springs.
Height = 40 cm. Weight = 25 kg.



SPRINGBOARD GUARD

Ref. 2115 - Complete guarding of the springboard (1.20 m long) providing safety during Yurchenko vaults. Fits to all springboards. Non-slip base.



SPRINGBOARDS

BEGINNERS SOFT SPRINGBOARD

Ref. 0014 - Classic springboard with 2 soft cylindrical springs. Ideal for beginners and school children. No cushioning layer.
Height = 23 cm. Weight = 22 kg.



HIGH ELASTICITY SPRINGBOARD - 25 cm

Ref. 2150 - With 2 tight cylindrical springs and 2 cm thick carpet cover. It makes vaulting repetitions easier.
Height = 25 cm. Weight = 23 kg.



TRAINING SPRINGBOARD - 21 cm

Ref. 2190 - With 2 tight cylindrical springs and board covered with 2 cm thick carpet.
Height = 21 cm. Weight = 24 kg.



TRAMPO-TREMP

Ref. 5090 - Specially developed to learn and work on jumping exercises. This item brings to gymnasts a significant gain in power. Dim. = 120 x 98 cm (Lxw).
It is similar in size to a standard springboard, meaning gymnasts do not need to change their run-up or last take-off point.
It is easily adjustable in height, 3 different positions: 26, 30 and 34 cm.
Weight = 27 kg.



Discover the inflatable "impulsion" modules on page 98





GVA

GYMNOVA

POMMEL HORSES



COMPETITION POMMEL HORSES

Pommel horses with standard legs and genuine leather or leatherette-covered body. Thanks to the body shape of the apparatus, gymnasts can work on a perfectly flat surface. Precise adjustment of pommel width thanks to new markings on the body.

Technical features:

- Body height adjusts between 0.90 and 1.40 m with engraved increments.
- Width instantly adjustable using thumb wheels from 38 to 47 cm.
- Wooden pommels made from plywood aluminium base plates.
- Non-slip pads.

Optional: transport trolleys (Ref. 3695 our 3697, see page 29) and guards (Ref. 2920 and 2922, see page 45).

Ref. 3570 Genuine leather-covered body 

Ref. 3540 Leatherette-covered body



Legs and floor anchoring system guards



New markings



Height adjustment and quick release

POMMEL HORSES



3572



3573

LOW POMMEL HORSES

Ideal for learning, these pommel horses are covered with leatherette. Precise adjustment of pommel width thanks to new markings on the body. Two versions available allowing mats of different thicknesses to be added.

Ref. 3572 - Pommel horse to accommodate a 10 cm deep mat. Height = 40 cm.

Ref. 3573 - Pommel horse to accommodate a 20 cm deep mat. Height = 50 cm.



Mats sold separately.

FOAM "MUSHROOM" KIT

Ref. 3590 - This unit is highly reassuring for learning pommel circles and is made throughout of highly resilient foam with PVC covers. Comprises 3 separate elements which can be purchased separately. Kit comprising a Ref. 3585, a Ref. 3587 and a Ref. 3589.

Ref. 3585 Disc

Used to raise the height of Ref. 3587 and 3589.
Ø = 80 cm. Height = 20 cm.

Ref. 3587 Cone

First training aid for beginners. Ø = 80 cm. Height = 52 cm.

Ref. 3589 "Giant" mushroom

Practice device for more confident gymnasts.
Ø = 100 cm. Height = 20 cm.

3589



3587



3585



"MUSHROOM"

Ref. 3581 - This "mushroom" (60 cm diameter) is used on the floor or at a height of 45 cm. Its base consisting of a metal «cross» with non-slip pads affords it great stability. It is supplied with a removable padded cover Ref. 3583. It can be used without the cover. One or two pommels can also be added (Ref. 3584 optional).

Accessories:

Ref. 3583 - Padded removable cover for "mushroom" Ref. 3581.

Ref. 3584 - Pommels for use on a "mushroom" or pommel horse. Pair.

Ref. 1399 - Mat specific to the mushroom Ref. 3581 with central opening and cut-out for the pedestal.

Dim. = 200 x 200 x 20 cm (Lxwxth).



3581

1399

POMMEL HORSES

POMMEL HANDLES

Ref. 3520 - Made from plywood with aluminium base plate. Supplied without fixing system. Pair.



REMOVABLE POMMEL HANDLES FOR BEAMS

Ref. 3586 - Designed to introduce smaller builds to pommel work. To be fitted to any beam body. The strap system allows the width of the handles to be adjusted according to different shoulder widths. Plastic finish. Supplied without protective pads. Pair.

Ref. 3588 - Protective pads. In order to protect the exercise zone, it is used with removable pommel handles Ref. 3586.



GUARDS

Ref. 2920 - For "standard" type GYMNOVA table, horse and beam legs. Set of 2.

Ref. 2922 - For vaulting table and horse chains. Unit.



FREESTANDING BASE

Ref. 2754 - Base system ideal for sports halls which cannot take floor anchors. Specially designed for GYMNOVA pommel horses. Dim. = 3.10 x 1.50 m. Thickness = 25 mm.



TRANSPORT TROLLEYS

Ref. 3695 - Omnidirectional castors that attach to pommel feet. See page 29.



RINGS



COMPETITION RING FRAME WITH ADJUSTABLE ELASTICITY

Ref. 3770 - Ring frame with adjustable elasticity (from "normal" to "very flexible"), which adapts to a gymnast's weight and style. Its high impact absorbency means that exercises can be practised repeatedly reducing fatigue and risk of strain injuries. Its flared shape enables the space in the landing zone to be cleared thereby ensuring maximum safety during dismounts. The cable length of the rings is pre-set, and the apparatus comes with a hook to catch and steady the rings. Overall frame height = 6.05 m.



Plywood rings

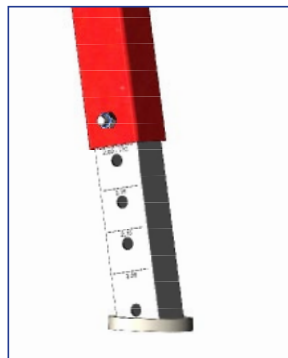

Height adjustment from the base

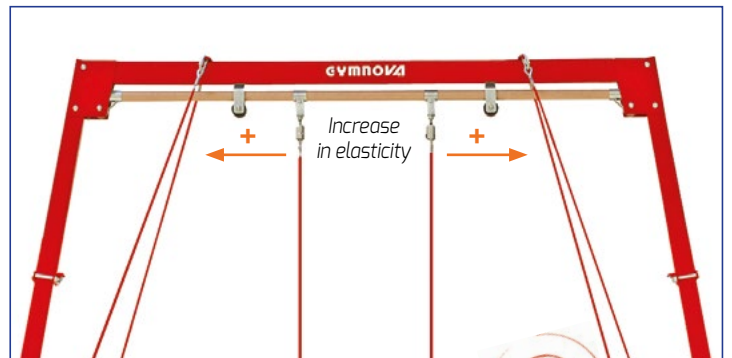

Adjustable elasticity

RINGS



3700

COMPETITION RING FRAME

Ref. 3700 - This frame is made from square-section tubing, with coated double cable system and rapid tensioners for quick assembly and dismantling. Supplied with factory adjusted rings and pole hook (crook) for settling the rings. Overall frame height = 5.90 m.

Optional: flex adjuster for ring systems Ref. 3790 (see page 50).

MINI RING FRAME

Ref. 0130

Allows children to develop their first gymnastics movements and sequences. Dismantled and easily transported, it is modular with rapid height adjustment from 0.21 to 1.21 m. Maximum frame height = 2.34 m.

Technical features:

- Plywood rings, \varnothing = 23.6 cm. Section = 2.8 cm.
- Space between uprights = 1.54 m (will accommodate 1.50 m mats)
- Floor space = 1.77 x 1.71 m.
- Non-slip pads.

Discover all our mini-apparatus on page 62.



RINGS

INVERTED FRAME

Perfect for training, it saves space in gyms. Attached to the ceiling or to a built-in frame, individual requirements will need to be considered for fitting.

Ref. 3765 - Inverted ring frame, height not adjustable. Equivalent to a standard frame.

Ref. 3768 - Adjustable flex inverted ring frame.



RING HANGING SYSTEM

Ref. 3761 - Ring hanging system can be fitted to a frame. This is an excellent teaching tool which can be used in schools and to introduce gymnasts to the rings. Height adjusts between 0.20 and 2.50 m. Kit comprises rings, cables and adjusting chains.

Use of a flex adjuster Ref. 3790 is recommended (see page 50).



WALL MOUNTED ASSEMBLY

Ref. 3750 - Wall bracket, height adjustable from 0.20 to 2.80 m. Folds away sideways, saving lots of space. Supplied with rings.

Use in conjunction with a flex adjusted Ref. 3790 for greater comfort (see page 50).

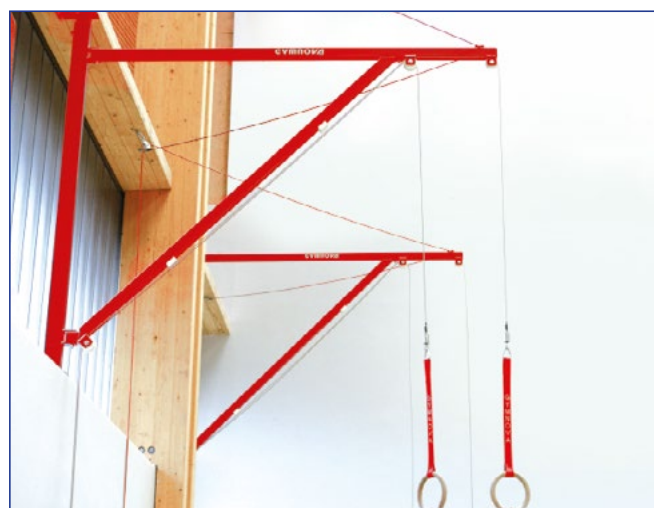

RINGS

ELASTANO

Ref. 3794 - Elastano is designed to help work on swing elements. Adjusts by altering the length of the elastics. Operates on the principle of taking the gymnasts' weight so that they can work on the technical elements. Comprises a binding system and belt, Ref. 2840.

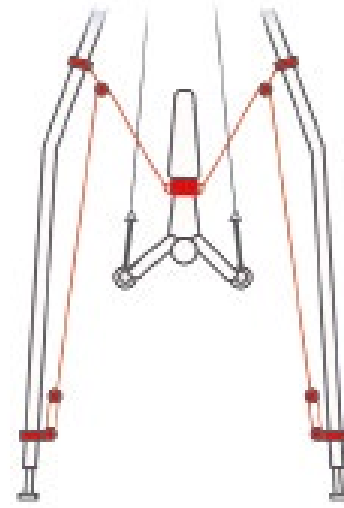

EDUCANO

Ref. 3735 - Educano is an accessory which assists work on strength elements on the rings. It helps with practising sequences such as handstand, handstand cross, L-position supports and planche.



FIFTY-FIFTY

Ref. 3795 - Allows gymnasts to work on all strength elements, with the principle of reducing their body weight by half. Gymnasts can practise their chosen technical movements over and over. Rings adjustable up to 2.80 m. Items supplied: ropes with pulley and swivel snap hook. Harness and rings not included. This product fits all GYMNOVA frames and harnesses. For built-in frameworks, please contact us.

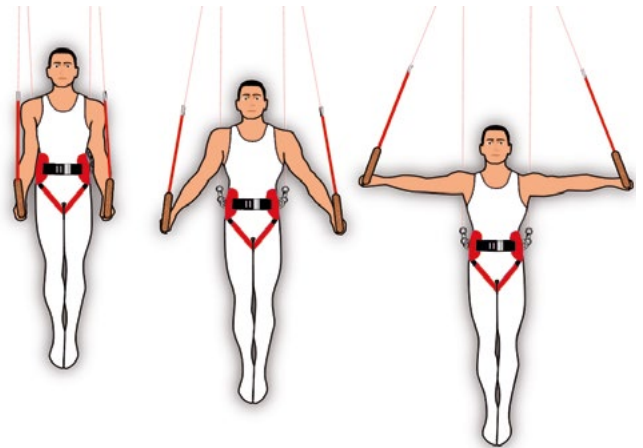

FLEX ADJUSTER FOR RING FRAMES

Ref. 3790 - A system which enables a traditional frame to be converted into a frame which is truly adjustable for elasticity: 5 positions including 0. By increasing shock absorption it reduces shoulder and spinal injuries. Ring height adjusts from 20 cm above the ground to competition height. For example, the rings can be brought right down to ground level. Supplied with cable system (rings not included). Attaches to Ref. 3700.

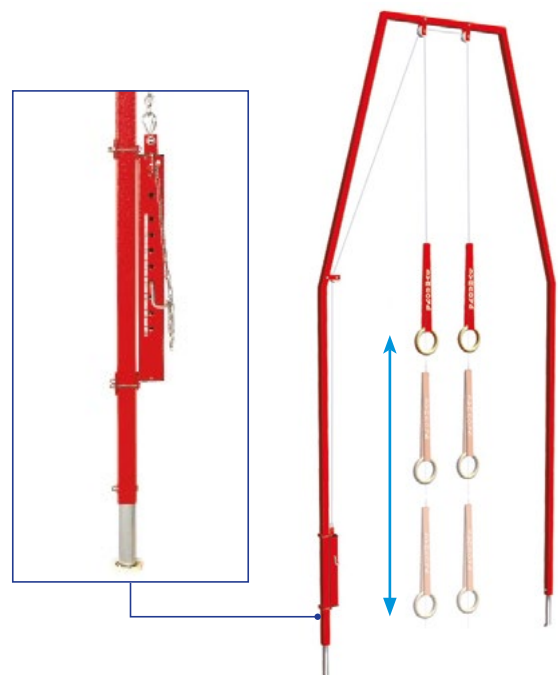

RINGS

3720



RINGS ONLY

Ref. 3720 - Plywood rings with straps and "delta" shaped triangular quick links. Pair. Cable not included.

3710



Ref. 3710 - Beginners' rings with adjustable straps specially designed for training. Instant attachment to high bars, parallel bars, frames... 500 mm adjustment. Pair.

3785



RING HOOK

Ref. 3785 - Essential accessory which allows to catch and steady the rings directly below frame.

CABLE GUARDS

Set of 2.

Ref. 2925 - Large model. L = 2 m.

Ref. 2926 - Small model. L = 1.20 m.



ACCESS PLATFORM

Ref. 2710 - It is specially designed to give easy access to a hanging system or frame, and has the advantage of being foldable.



PARALLEL BARS



COMPETITION PARALLEL BARS

Parallel bars with reinforced rails. Bar height adjusts between 1.70 and 2.30 m. Distance between bars adjusts between 37.50 and 65 cm via metal "goose neck" with width marked on calibrated disc. Tightening levers, stainless steel sliding uprights with height adjustment knobs and engraved centimetre scale. Base with non-slip feet.

 **Ref. 3832** - Parallel bars with reinforced frame. Floor space = 3.42 x 2.55 m. Weight = 240 kg.

Ref. 3830 - Parallel bars without reinforced frame. Floor space = 2.55 x 2 m. Weight = 170 kg.



Reinforced hand-rail



Metal "goose neck"



Reinforced frame

PARALLEL BARS



TRAINING PARALLEL BARS

Various versions available (with or without foldable legs), these parallel bars are fitted with a cam lever for tightening and 3.50 m plywood hand-rails. Height adjustable between 1.40 and 2 m. Distance between bars adjusts between 37.50 and 65 cm, via composite material "goose necks". Base with non-slip pads.

Floor space:

- Fixed base = 2.58 x 2 m (Ref. 3920)
 - Folding base = 2.58 x 0.90 m (Ref. 3910 and 3915)
- Transport trolleys Ref. 3850 optional for Ref. 3920 (see page 23).

Ref. 3910 - Folding base parallel bars and transport trolleys.
Weight = 150 kg.

Ref. 3915 - Folding base parallel bars, transport trolleys and custom folding mat Ref. 7080 (see next page).
Weight = 215 kg.

Ref. 3920 - Fixed base parallel bars. Weight = 135 kg.



Width adjustment



Composite material "goose neck"



Integrated transport trolleys

PARALLEL BARS

3907



"COMPACT" PARALLEL BARS

Available in several versions, these parallel bars are ideal for those who need to set up and take down the equipment at every session.

Technical features:

- Height adjustable from 1.15 m to 1.85 m using a system of locking notches and thumb wheels.
- Distance between bars adjusts between 37.50 and 65 cm, via composite material "goose necks".
- Base with non-slip pads.

Possible to purchase parallel bars with or without the folding mat Ref. 7080.
Parallel bars with folding feet allow the reduction of the overall storage space needed.
Dim. when folded (without trolleys) = 2.58 x 0.90 m (Lxw).



Ref. 3906 + Ref. 7080 = Ref. 3907



REF.	FEET	TRANSPORT TROLLEYS	FOLDING MAT REF. 7080
3900	Fixed	no	no
3905	Fixed	yes	yes
3906	Folding	yes	no
3907	Folding	yes	yes

3900



CUSTOM FOLDING MAT

Ref. 7080 - Fits on GYMNOVA parallel and mixed bars (see page 21).
Dim. = 430 x 260 x 20 cm (Lxwxh).

NOTE: using mats requires the bars to be fitted with the transport trolleys Ref. 3850.

Compliant with European standard NF-EN 12503.

PARALLEL BARS

PIT MOUNTED FOLDING PARALLEL BARS

Ref. 3931 - Makes optimum use of the available space around a landing pit. With their sideways-folding feet, these bars can be folded against a wall when not in use. Identical to Ref. 3920, these bars can be adjusted in height from 1.45 to 2.05 m and in width from 37.5 to 65 cm. Supplied with leg guards Ref. 2960.



FOAM PARALLEL BARS

Ref. 3865 - Training foam parallel bars comprises 4 detachable modules:

- 2 lower modules. Dim. = 160 x 58 x 100 cm.
- 2 upper modules. Dim. = 160 x 58 x 12 cm.
- 1 stabilizing unit. Dim. = 180 x 160 cm.
- 1 safety mat. Dim. = 200 x 50 x 3 cm.

The stability of the set together with the quality of the foam provides cushioning and reassurance for gymnasts, whilst being sufficiently rigid to maintain a degree of support which is close to the real thing for situations encountered on parallel bars. Distance between bars adjusts up to 64 cm.

The modules can be used separately to create teaching workshops but you are advised always to use the parallel bars with the upper modules.



MINI PARALLEL BARS

Ref. 0122 - Allow children to develop their first gymnastics movements and sequences. Removable and transportable, they are modular. Easy spacing adjustment between 0.25 and 1.30 m. and height adjustment from 0.90 to 1.40 m.

Technical features:

- Round fibreglass hand-rails, $\varnothing = 3.50$ cm.
- Distance between uprights: 1.54 m (will accommodate 1.50 m mats, not supplied).
- Floor space = 1.77 x 1.71 m (Lxw).
- Non-slip feet.

Discover all our mini-apparatus on page 62.



PARALLEL BARS



HAND-RAILS

For parallel and unisex bars. Oval. Length = 3.50 m. Unit.

Ref. 3860 Non-reinforced rail

Ref. 3861 Reinforced rail. With PVC support
(Pre-2007 model).

Ref. 3862 Reinforced rail. With metal support
For Ref. 3832 only (Post-2007 model).



PROTECTIVE SLEEVES

Ref. 2930 - For parallel bars hand-rails, highly shock-absorbent foam. Length = 1 m. Set of 4.

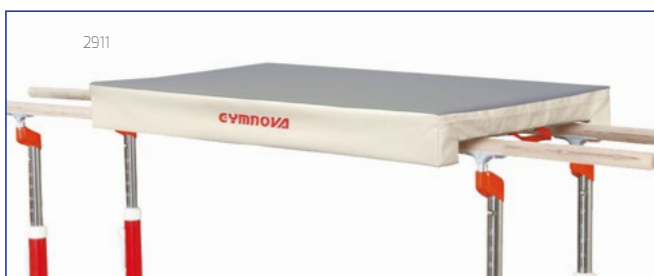

FLIGHT PROTECTION

Ref. 2911 - Protection specifically designed for practising all acrobatic elements over the parallel bars. The U-shaped mat fits over the bars and moves into place during flights and dismounts. Promotes smooth, fast progression. Allows gymnasts to land on their front, back or feet. Jersey top cover and "leather look" underside with reinforcement "real leather". Removable cover. Dim. = 150 x 90 cm (Lxw).

UPRIGHTS GUARDS

Parallel bars uprights guards. Set of 4.

Ref. 2950 - For training bars Ref. 3910, 3915 and 3920.

Ref. 2955 - For competition bars Ref. 3832 and 3830.



LOW PARALLEL BARS

Ref. 3991 - Wooden. Folding for optimised storage. Distance between bars adjusts between 35 and 50 cm. Genuine oval parallel bar rails. Dim. = 115 x 15 cm (Lxw).



BALANCING HANDLES

For learning handstands and for strength training. Wooden. Pair.

Ref. 3985 - $\varnothing = 39$ mm, L = 40 cm.

Ref. 3987 - $\varnothing = 39$ mm, L = 80 cm.



SPOTTING PLATFORM

Ref. 3980 - Fits easily to all Gymnova parallel bars, height is adjusted using a ratchet system (adjustment range = 300 mm). Foldable and easily transportable, enables the coach to spot the gymnast and allows access to apparatus.

CENTRAL BEVELLED UNDERLAY

Ref. 3855 - For all our freestanding bars (parallel and asymmetric bars).

Dim. = 209 x 46 x 6 cm (Lxwxh). Weight = 3 kg.





HIGH BARS



COMPETITION HIGH BARS

This model features solid steel machined rotating heads. The two rotation axis are mechanically designed to give a perfectly jolt free "gimbal" effect. The uprights for this bar are 70 mm in diameter, easy assembly and dismantling via rapid tensioners. Non-slip feet, coated cables. Height adjusts between 2.70 and 2.95 m.

REF.	DESCRIPTION	HAND-RAIL	FIG	FLOOR SPACE
3020	Standard cable "London" high bar	Standard Ref. 3110		5.50 x 4 m
3025	Short cable "London" high bar	Standard Ref. 3110		4 x 2 m
3030	Standard cable "Montreal" high bar	With safety cable Ref. 3117		5.50 x 4 m
3035	Short cable "Montreal" high bar	With safety cable Ref. 3117		4 x 2 m

NEW
NEW



Rotating head in steel



Feet height adjustment



Hand-rail Ref. 3117

HIGH BARS



ADJUSTABLE HIGH BARS

High bars adjustable from 0.95 to 2.75 m. Ideal for learning. Bar height is adjustable from 0.95 m to 2.75 m in 20 cm then 10 cm increments. Easy assembly, dismantling and tension adjustment via rapid tensioners. Can also be used with asymmetric bars wooden hand-rail. Supplied with steel hand-rail Ref. 3110.

If it is impossible to drill the floor, use a connecting flat (Ref. 3120/62), to maintain the distance between uprights (sold separately).

Ref. 3120 Standard cable high bar

Floor space = 5.50 x 4 m.

Ref. 3125 Short cable high bar

Floor space = 4 x 2 m.



Ref. 3125 with asymmetric bars wooden hand-rail

HIGH BARS WITHOUT CABLE

High bars with uprights in Ø 90 mm steel tubing. Fixed into casings and tightened manually. Rails mounted in omnidirectional pivots to prevent jolting. Height adjusts between 0.95 m and 2.55 m. Distance between uprights either 2.40 m or 2.54 m. Supplied with high bar rail Ref. 3110, and can also take asymmetric bars rail Ref. 3260, 3262, 3265 or 3268.

This type of cableless bar requires the upright casings to be fixed into the floor (please contact us).

Distance between uprights 2.40 m:

Ref. 3101 - 1-person bar (2 uprights, 1 rail).

Ref. 3102 - 2-person bar (3 uprights, 2 rails).

Ref. 3103 - 3-person bar (4 uprights, 3 rails).

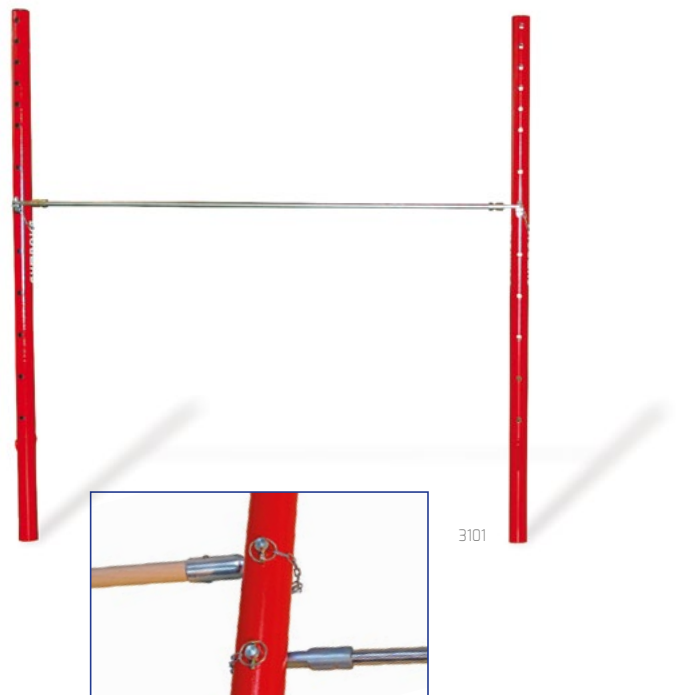

Compatible with an asymmetric bars hand-rail

HIGH BARS

HAND-RAILS

Made from special stainless steel. Adaptable at all GYMNOVA bars. Unit.

Ref. 3110 Standard hand-rail

Ref. 3117 Hand-rail with safety cable



CABLE SYSTEMS

Ref. 3011 - Standard cable system only for standard set-up area. Floor space = 5.5 x 4 m.

Ref. 3012 - Short cable system only. Anchoring system for apparatus which reduces required floor space by 60%.

This unique system requires special anchor points to be installed. Please contact us.

Floor space = 4 x 2 m.



GUARDS

Ref. 2925 Cable guards medium model

Length = 2 m. Set of 2.

Ref. 2931 Cables and tighteners guards

Large guards for high bars and spotting frames.

Length = 2.50 m. Set of 4.

Ref. 2940 Uprights guards

Height = 2 m. Set of 2.

PROTECTION PAD FOR FLIGHT ELEMENTS

Ref. 2910 - Supplied with a handle, the coach throws it on the bar when gymnast releases the bar. Length = 1.40 m.



MINI HIGH BAR

Ref. 0125 - Allows children to develop their first gymnastics movements and sequences. Removable and transportable, it is modular. Easy height adjustment from 0.90 to 1.40 m.

Technical features:

- Round fibreglass hand-rail, $\varnothing = 3.50$ cm.
- Distance between uprights: 1.54 m (will accommodate 1.50 m mats, not supplied).
- Floor space = 1.77 x 1.71 m (Lxw).
- Non-slip feet.

Discover all our mini-apparatus on page 62.



MINI-APPARATUS



These mini apparatus modules have been tested in major gymnastics and motor skill development centres. They allow children to develop their first gymnastics movements and sequences. They can be dismantled and easily transported and are modular with rapid height and spacing adjustment.

Common features:

- Round fibreglass hand-rails, \varnothing : 3.50 cm except Ref. 0130.
- Distance between uprights: 1.54 m (will accommodate 1.50 m mats, not supplied).
- Floor space = 1.77 x 1.71 m (Lxw).
- Non-slip feet.

MINI ASYMMETRIC BARS

Ref. 0120 - Spacing adjustment between 0.25 and 1.30 m. Height adjustment:

- Low bar = 0.90 and 1.40 m.
- High bar = 1.40 and 1.90 m.

MINI PARALLEL BARS

Ref. 0122 - Height adjustment between 0.90 and 1.40 m. Distance between bars adjusts between 0.25 and 1.30 m.

MINI HIGH BAR

Ref. 0125 - Height adjustment between 1.40 and 1.90 m.

MINI RING FRAME

Ref. 0130 - Height adjustment between 0.21 and 1.21 m. Maximum frame height = 2.34 m.

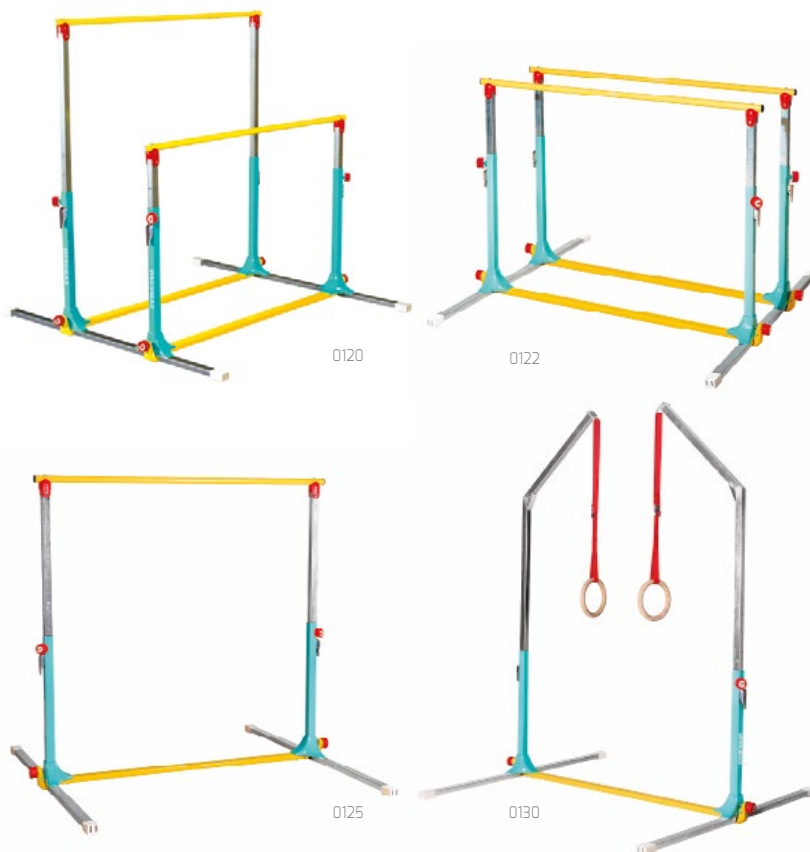



MATS



ЧЕМПИОНАТ
ОБЛАСТНОГО
УНИВЕРСИТЕТСКОГО
АКТИВНОСТИ
6-9

Капитал Банк

Спирит

Капитал Банк

LANDING MATS LAYOUTS

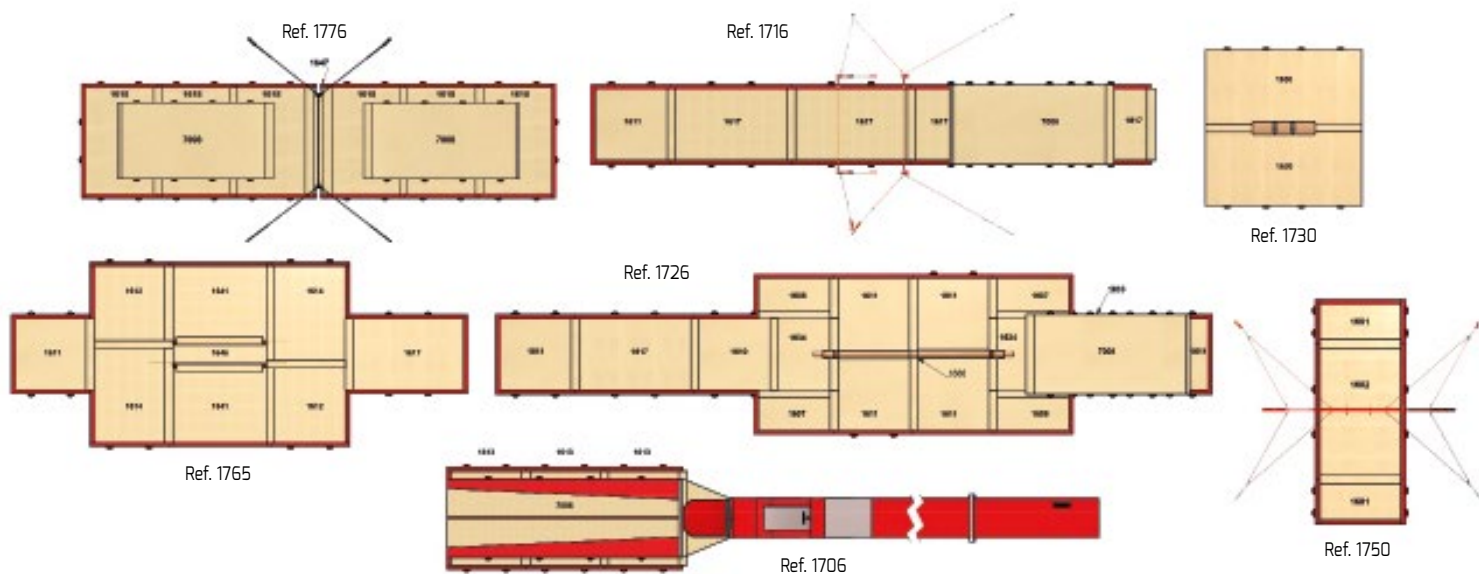

FIG landing mats made from multi-layered foam providing improved load distribution and optimum stabilisation when landing. They provide cushioning and shock absorption helping gymnasts to further develop their confidence as they extend their ability levels and technique. Fitted with carrying handles and a hook-and-loop strips attachment system (top side) to avoid gaps. Some mats have "cut-outs" to allow them to fit around the apparatus bases. Class M2 fire rating 1,000 denier "leather look" removable PVC cover.

REF.	DESCRIPTION	SURFACE	SPECIFICITIES	FIG
1705	Set of landing mats for competition vaulting.	15,60 m ²		
1706	Set of landing mats for competition vaulting.	15.60 m ²	Top-mat Ref. 7006	
1715	Set of landing mats for competition asymmetric bars.	28 m ²		
1716	Set of landing mats for competition asymmetric bars.	28 m ²	Top-mat Ref. 7008	
1725	Set of landing mats for competition beam.	52 m ²		
1726	Set of landing mats for competition beam.	52 m ²	Top-mat Ref. 7008	
1730	Set of landing mats for competition pommel horse.	16 m ²		
1750	Set of landing mats for competition rings.	10 m ²		
1765	Set of landing mats for competition parallel bars.	41 m ²		
1771	Set of landing mats for competition high bar.	24 m ²		
1776	Set of landing mats for competition high bar.	37.50 m ²	2 top-mats Ref. 7008	

FIG LANDING MATS



1605



Similar specifications to sets of mats page 65.

REF.	DIM. (Lxwxth)	USE
TRADITIONAL 2 m WIDE MODELS		
1606	100 x 200 x 20 cm	All apparatus except vault and pommel. Hook-and-loop bib across width.
1611	200 x 200 x 20 cm	
1617	300 x 200 x 20 cm	
1605	100 x 200 x 20 cm	All apparatus except vault and pommel. Hook-and-loop bib down length.
1618	300 x 200 x 20 cm	
1620	400 x 200 x 20 cm	All apparatus except vault and pommel. No hook-and-loop bib.
1621	400 x 200 x 20 cm	All apparatus except vault and pommel. Hook-and-loop bib across width.
TRADITIONAL 2.30 m WIDE MODELS		
1410	100 x 230 x 20 cm	All apparatus except vault and pommel. Hook-and-loop bib down 2.30 m on the side.
1430	200 x 230 x 20 cm	
1435	300 x 230 x 20 cm	
1440	400 x 230 x 20 cm	
CUSTOM MATS		
1601	200 x 100 x 20 cm	Custom mats for rings.
1602	300 x 200 x 20 cm	
1607	100 x 200 x 20 cm	Right angle hand extra mat for competition beam layout.
1608	100 x 200 x 20 cm	Left angle hand extra mat for competition beam layout.
1610	200 x 200 x 20 cm	Standard mat with female hook-and-loop bib on top surface.
1612	210 x 200 x 20 cm	For competition parallel bars layout. With base cut-outs.
1614	260 x 200 x 20 cm	
1613	200 x 260 x 20 cm	For competition vaulting layout.
1616	300 x 200 x 20 cm	Custom mat for beam with base cut-outs.
1619	400 x 200 x 20 cm	
1634	200 x 150 x 20 cm	
1635	450 x 200 x 20 cm	
1636	200 x 200 x 20 cm	
1630	400 x 200 x 10 cm	Custom mat for pommel horse with base cut-outs.
1631*	400 x 200 x 20 cm	
1641	260 x 200 x 20 cm	Custom mat for parallel bars with base cut-outs.
1644	260 x 200 x 20 cm	
1646	260 x 70 x 20 cm	
1647	300 x 50 x 20 cm	Centre mat for high bar.

* Non-compliant with FIG standards.



1616



1646



Multi-layered foam



Mats with base cut-outs

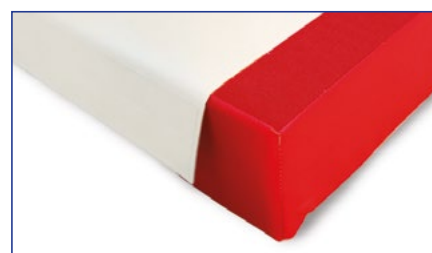

Hook-and-loop bib on the side and female on the top

ADDITIONAL LANDING MATS



 **Ref. 7006** - A top mat to be placed over the vaulting landing area to provide additional cushioning and safety for gymnasts. The 1,000 denier "leather look" PVC cover clearly replicates the regulation landing surface, compliant with FIG standards. Overall dim. = 600 x 200 x 10 cm. Dimensions of the authorized area = 0.95 x 1.50 m. Compulsory in FIG competition. Attaches by hook-and-loop strips to guard Ref. 2921. 8 carrying handles, non-slip base.

Additional mats to use on top of landing mats. 1,000 denier "leather look" PVC cover with non-slip base.

Ref. 7003

Dim. = 200 x 200 x 5 cm (Lxwxth). 4 carrying handles.

Ref. 7005

Dim. = 200 x 200 x 10 cm (Lxwxth). 4 carrying handles and 1 hook-and-loop attachment strip.

Ref. 7008

Dim. = 400 x 200 x 10 cm (Lxwxth). 8 carrying handles, linking bib and hook-and-loop strip attachment.



7005



7008



7003

SAFETY MATS



Our safety mats are made from top quality materials for optimum cushioning and durability. Different densities of polyethylene and polyurethane foam for different uses.

Class M2 fire rating 1,000 denier "leather look" PVC cover, with carrying handles. Non-slip bases, decompression holes or grid and reinforced corners. Available in several different configurations (single density, dual density, stretch fabric top...).

FEATURES	REF.	FOAM DENSITY	WEIGHT	DIM. IN CM (Lxwxth)	REF. COVER ONLY	TOP COVER
ADDITIONAL CUSTOM MATS, TOP-MATS - Single density						
Non-slip - Reinforced corners - No hook-and-loop attachment strips. To use as top-mats to increase comfort while training.	7001	28 kg/m ³	15 kg	200 x 140 x 10	7007	PVC
	7011	28 kg/m ³	14 kg	200 x 140 x 10	7017	JERSEY
	7023	21 kg/m ³	18 kg	200 x 150 x 20	7028	JERSEY
	7033	21 kg/m ³	30 kg	240 x 200 x 20	7029	JERSEY
	7053	21 kg/m ³	50 kg	300 x 200 x 30	7059	JERSEY
TRADITIONAL - Single density						
Non-slip - Reinforced corners - No hook-and-loop attachment strips.	7021*	21 kg/m ³	18 kg	200 x 150 x 20	7027	PVC
	7031*	21 kg/m ³	30 kg	240 x 200 x 20	7037	PVC
	7041*	21 kg/m ³	34 kg	300 x 200 x 20	7047	PVC
	7051*	21 kg/m ³	51 kg	300 x 200 x 30	7057	PVC
STANDARD - Single density						
Non-slip - Reinforced corners - Hook-and-loop attachment strips.	7032*	21 kg/m ³	30 kg	240 x 200 x 20	7038	PVC
	7042*	21 kg/m ³	34 kg	300 x 200 x 20	7048	PVC
TRADITIONAL - Dual-density						
1 firm side, 1 soft side, reversible. No hook-and-loop attachment strips - Without reinforced corners.	7036*	30/21 kg/m ³	34 kg	240 x 200 x 20	7039	PVC
	7046*	30/21 kg/m ³	42 kg	300 x 200 x 20	7049	PVC
APPARATUS LANDING MATS - Dual-density						
1 hard size for stable landings. Non-slip - Hook-and-loop attachment strips - Reinforced corners.	7034*	30/21 kg/m ³	34 kg	240 x 200 x 20	7038	PVC
	7044*	30/21 kg/m ³	42 kg	300 x 200 x 20	7048	PVC

* Compliant with European standard NF-EN 12503.



7031



7011



Reinforced corners



Attachment hook-and-loop bib



Carrying handle

SAFETY MATS

FOLDING MATS

Ideal for training or school environment. They are made of durable polyurethane foam with 1,000 denier "leather look" PVC covers. Carrying handles. Decompression holes or grids.



7056 unfolded

Ref. 7056 - Traditional landing mat = 400 x 200 x 20 cm.
Non-slip base. Dim. folded = 200 x 200 x 40 cm. Weight = 48 kg.
Compliant with European standard NF EN 12503.

Ref. 7058 - PVC cover only for folding mat Ref. 7056.



7056



7068 unfolded

Ref. 7068 - Traditional landing mat = 250 x 200 x 25 cm.
Dim. folded = 250 x 100 x 50 cm.
May be used as a landing block thanks to its reversible cover.
Weight = 30 kg.

Ref. 7069 - PVC cover only for folding mat Ref. 7068.



7068 folded

LANDING BLOCKS



7075



7070

COVERED FOAM BLOCK

These mats have been designed with a high quality very soft foam. Covered in durable, washable class 2 fire rating 1,000 denier "leather look" PVC. Decompression by means of grids on two long sides. 4 straps and buckles for creating custom-size landing areas. Non-slip base.

Ref. 7070

PVC foam block 200 x 100 x 50 cm (Lxwxh).
With 4 carrying handles. Weight = 21 kg.

Ref. 7100

PVC foam block 400 x 200 x 50 cm (Lxwxh).
With 8 carrying handles. Weight = 78 kg.

Ref. 7075

Foam block 200 x 100 x 50 cm (Lxwxh) with stretch jersey top fabric for a more comfortable landing.
Weight = 19 kg.

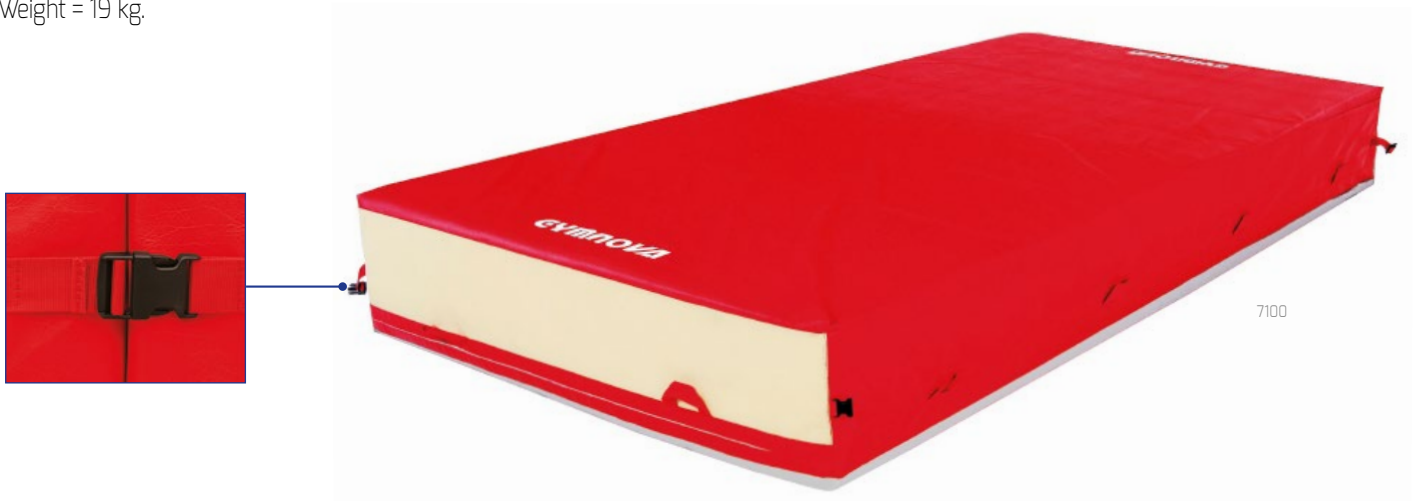

7100

ACCESSORIES

Ref. 7071 - PVC cover only for Ref. 7070. Dim. = 200 x 100 x 50 cm (Lxwxh).

Ref. 7076 - Jersey cover only for Ref. 7075. Dim. = 200 x 100 x 50 cm (Lxwxh).

Ref. 7078 - Foam block only for Ref. 7070 and Ref. 7075. Dim. = 200 x 100 x 50 cm (Lxwxh). Density = 17 kg/m³.

Ref. 7101 - PVC cover only for Ref. 7100. Dim. = 400 x 200 x 50 cm (Lxwxh).

LANDING BLOCKS AND ACCESSORIES



COMFORT MATS

The underside of the cover is made from class 2 fire rating 1,000 deniers "leather look" PVC and the top of cover is washable class 1 fire rating stretch jersey. Halfway between a traditional mat and a landing pit.

Ref. 7090 "Large" comfort mat

Dim. = 350 x 200 x 65 cm. 12 carrying handles.
Weight = 80 kg.

Ref. 7091 "Small" comfort mat

Dim. = 200 x 150 x 65 cm. 8 carrying handles.
Weight = 37 kg.

ACCESSORIES

Ref. 7088 Jersey cover only for Ref. 7090

Dim. = 350 x 200 x 65 cm (Lxwxh).

Ref. 7089 Jersey cover only for Ref. 7091

Dim. = 200 x 150 x 65 cm (Lxwxh).

TRANSPORT TROLLEYS

Transport trolleys for storage of mats equipped with large diameter omnidirectional castors. Maximum load = 650 kg.

Ref. 6060 Trolley for horizontal storage

Dim. = 210 x 122 (Lxw). Handle height = 1.28 m.



Ref. 6065 Trolley for vertical storage

Dim. = 310 x 153 x 140 cm (Lxwxh). Weight = 98 kg.



MATS FOR SCHOOL



Mats for school use. Lightweight polyethylene foam, class M2 fire rating 1,000 denier "leather look" PVC cover. Non-slip base, available with or without lined reinforced corners. Available in various sizes, with or without peripheral hook-and-loop attachment. Compliant with European standard NF-EN 12503.



Reinforced corners



Non-slip underside

REF.	SET OF 5	WEIGHT	HOOK-AND-LOOP STRIPS	REINFORCED CORNERS
200 x 100 CM MATS - THICKNESS 4 CM				
6000	6001	7 kg	no	no
6006	6007	7 kg	yes	no
6100	6101	7 kg	no	yes
6102	6103	7 kg	yes	yes
200 x 125 CM MAT - THICKNESS 5 CM				
6110	6111	10 kg	no	no
200 x 100 CM MATS - THICKNESS 5 CM				
6050	6051	8 kg	yes	no
6107	6108	8 kg	yes	yes
6115 ⁽¹⁾	6116	8 kg	yes ⁽²⁾	no
200 x 150 CM MAT - THICKNESS 6 CM				
6031	6032	11 kg	yes	no

(1) Model with side strips.

(2) Hook-and-loop strips across width. Models designed to be made to measure for tumbling. Size variation allowed: 2%.

CARTWHEEL MAT

Ref. 0471 - A mat for learning how to do cartwheels. The visual guides help child gymnasts work on alignment and positioning in a fun way. Colour: red.
Dim. = 200 x 50 x 4 cm (Lxwxth). Weight = 3 kg.



TUMBLING TRACKS

Concertina folding tumbling tracks:

Our tumbling tracks are designed with two different concertina folding techniques:

- 1 - "Traditional" stitched groove folding mechanism.
- 2 - Extra-wide (100 mm) hook-and-loop linking and folding strip.

Advantages of the design:

- May be used as single-section tracks when joined together.
- Lighter and more manageable (three 4 m tracks are easier to transport than one 12 m track).
- Tracks can be made to measure.



FOLDING TUMBLING TRACKS

Ref. 6120

Concertina folding track for creating tumbling areas.

Single colour, with peripheral hook-and-loop strips around edges.

Dim. = 200 x 200 x 5 cm.

Folds in two. Folded dim. = 200 x 100 x 10 cm.

Examples:

- To create a 8 x 8 m tumbling area, you will need 16 x Ref. 6120.
- To create a 10 x 10 m tumbling area, you will need 25 x Ref. 6120.

Concertina folding tracks for making linear tumbling areas. Two-tone, with side strips and hook-and-loop strips at ends.

Ref. 6126* - Dim. = 400 x 100 x 5 cm.

Folds in two. Folded dim. = 200 x 100 x 10 cm.

Ref. 6124* - Dim. = 200 x 200 x 5 cm.

Folds in two. Folded dim. = 200 x 100 x 10 cm.

Ref. 6115* - Matching mat compatible with Ref. 6126.

Dim. = 200 x 100 x 5 cm.

Examples:

- To create a 10 x 1 m track, you will need 2 x Ref. 6126 and 1 x Ref. 6115.
- To create a 12 x 2 m track, you will need 6 x Ref. 6124.

* Compliant with European standard NF-EN 12503.

MULTI-PURPOSE "CARPETTE" MAT

Ref. 6016

Multi-purpose mat, made from very soft and highly shock-absorbent foam, covered in stretch jersey and with a non-slip base. It is particularly well suited to use on a beam thanks to its ability to mould to the contour of the apparatus.

Dim. = 150 x 100 cm. Thickness = 1.5 cm.



TUMBLING TRACKS

ROLL-UP TUMBLING TRACK

Ref. 6160

Track made up of needled-pile carpet (bonded) on a class M4 fire rated dynamic foam.

These tracks can be joined together to make up larger tumbling surfaces. They are joined together with hook-and-loop strips that attach directly to the carpet. They roll up, which makes them easy to store. Non-slip underside. Dim. = 1400 x 200 x 4 cm (Lxwxth).



6160



Example: 7 roll-up tracks are needed to make up an exercise floor Ref. 6573. (See page 12).

"EASY-ROLL" TRACKS

Roll-up track for gymnastics and cheerleading.

Quick and easy installation make it ideal for use in schools and leisure centres.

The cut-foam backing is designed so that it can be rolled up easily without getting damaged and without having to turn it over.

Track is constructed of Polyethylene foam covered in a class 4 fire rating needled-pile carpet which offers a high degree of shock absorption and maximum safety on landing.

Thickness = 4 cm.

Ref. 6165 Easy-Roll 14 x 2 m

Rolled-up size: \varnothing = 100 cm.

Ref. 6166 Easy-Roll 7 x 2 m

Rolled-up size: \varnothing = 75 cm.



6165



SPECIAL ACROBATICS SAFETY MAT

Ref. 7064

When laid over an exercise floor or a track, it enables exercises to be repeated and it facilitates specific physical strengthening (under no circumstances must it be used on a hard floor).

It is fitted with 8 carrying handles and hook-and-loop strips at the ends for creating 10 m long tracks. One-piece mat.

Beige central strip provides a visual alignment guide.

Dim. = 500 x 140 x 10 cm. (Lxwxth).



LANDING PITS

GYMNOVA

GYMNOVA

LANDING PITS

This kind of pit has the following advantages:

- The design of this pit model enables it to be exited easily and without effort after use.
- Landing area visible: the top of the pit is raised 20 cm above the ground (FIG mats height).
- Pit edges are completely guarded, providing improved safety for gymnasts.
- Hygienic, reduced fire risk and easy to maintain.
- Provides phased shock absorption.



Ref. 7093 SUSPENDED SUNKEN PIT

Technical features:

- 1 Cover fabric** - Stretch jersey, washable, class M1 fire rated. Prevents formation of foam particles.
- 2 Moulded PVC edge** - Moulded PVC edge holds down jersey cover. Removable to make it easier to dismantle and tighten the cover.
- 3 Foam safety mat** - Shock absorption phase 1: very soft, shock absorbent polyurethane foam, thickness 20 cm (specially developed by GYMNOVA).
- 4 Protective interface** - Distributes loads at pit edges, protects foam from concrete, bungee cords and hooks.
- 5 Support net** - Shock absorption phase 2: knot-free synthetic net to prevent premature wear of the foam.
- 6 Looped bungee cords** - Net-tensioning calibrated bungee cords. The use of several bungee cords makes the pit safe (in the event of breakage) and allows the cords to be changed easily (for maintenance or to re-tension the net).
- 7 Attachment hooks** - Custom-flattened shape, made from zinc-coated steel.
- 8 Adjustable dip** - Compensating (for large areas) This system, comprises nylon stretch straps and snaphooks. Used to adjust the elasticity of the net and re-tension the pit.

Minimum depth = 1.20 m.

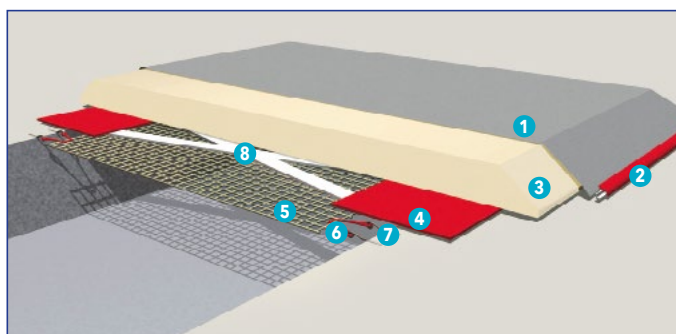

LANDING PITS

FULL BUILT-IN PIT

Ref. 7098 - Provides all the advantages of a GYMNOVA pit (easy exit, visible landing area, hygienic, safe, reduced fire risks) with an advanced design and choice of products.

This pit provides real cushioning for landings, far superior to the technique used for high jump landing (foam lattice).

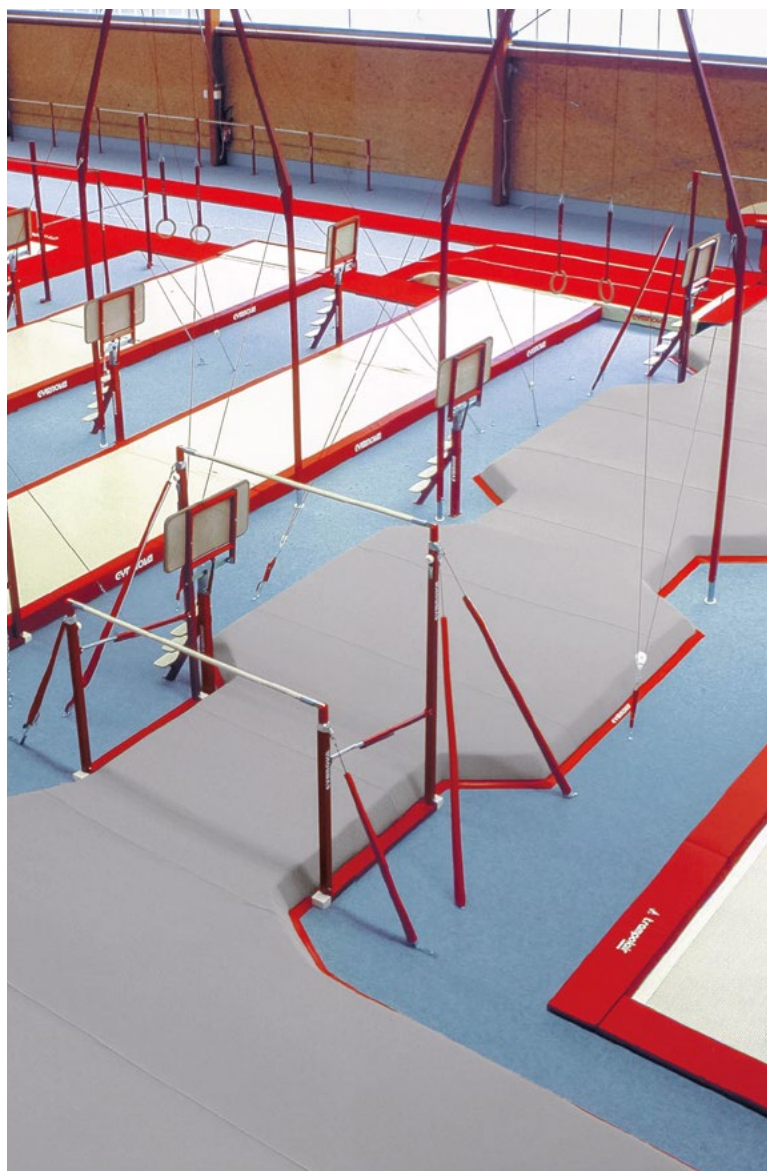

Technical features:

- 1 Cover fabric** - Stretch jersey, washable, class M1 fire rated. Prevents formation of foam particles.
- 2 Moulded PVC edge** - Moulded PVC edge holds down jersey cover. Removable to make it easier to dismantle and tighten the cover.
- 3 Foam safety mat** - **Shock absorption phase 1:** very soft, shock absorbent polyurethane foam, thickness 20 cm. (specially developed by GYMNOVA).
- 4 Protective interface** - Distributes loads at pit edges, protects foam from concrete.
- 5 Interlocking solid cellular foam sections**
Shock absorption phase 2: the moulded shape of the middle safety mat absorbs impact.
Shock absorption phase 3: interface support mat for continuous shock absorption by cancelling out the rebound effect.
- 6 Side maintenance block** - **Stability:** whole unit is set in to restore appearance after landing.
- 7 Spring compensator** - **Adjustment:** maintains the volume of the pit by reinforcing the landing areas which receive most stress.
- 8 Grating** - Covers the whole pit area. Isolates foam from the ground and allows complete ventilation, thus helping to prevent premature deterioration of the foam due to natural humidity.

Minimum depth = 0.62 m.

NOTE: for pit rebuilds (depth greater than 0.62m), we insert a special wooden or foam raising platform.

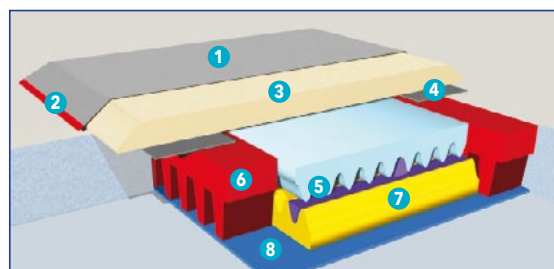

RAISED PIT WITH INTEGRATED PLATFORM

Ref. 7099 - Design identical to the pit Ref. 7098 but "above ground", with a platform and wooden guard rail. This type of pit avoids the need for masonry work.

LANDING PITS



NEW



RAISED PIT

Ref. 7097 - This type of pit is perfect for temporary gyms or gyms that might be dismantled because this method avoids digging into the ground. The level of comfort and flexibility it offers is identical to standard pits, it is designed to ensure a uniform landing surface. This prefabricated concept means the pit can be installed quickly and easily by just 2 people in a single day.

Technical features:

- Lower blocks: 600 mm thick cross-groove foam comprising a variety of densities to adapt to users in different landing zones. This type of foam ensures good air circulation and so optimal shock absorption.
- 200 mm thick dual-density mat, including a 50 mm "comfort" top layer. This very stretchy and strong dual-density foam creates a soft landing and ensures a long-lasting landing surface.
- M1 fire-rated stretch jersey cover fabric.
- The apparatus are installed on a raised platform so that they are at the same height.



LANDING PITS



NEW

SUNKEN PIT WITH FOAM CUBES

Ref. 7094 - This traditional pit system provides effective shock absorption for landings. The presence of 3 different sizes of foam cubes contributes to their sweeping. Although it does not have the same advantages as closed pits in terms of fire safety, the foam cubes can be covered with class M1 fire rated retardant covers (on request).

Comprises:

- Foam edge protection.
- Foam cubes.
- 200 mm thick dual-density mat.
- 600 mm thick cross-groove foam base.

Minimum depth = 1.50 m.

COMBINED PIT

This model is a combination of the two major principles, namely the cube pit and the stretched bed pit.

Offers greater versatility for pit work. Design on request.



LANDING PITS

INFLATABLE PIT

Offers the same absorption performance as conventional pits. These pits have been specially designed to allow gymnasts to adjust pit height and density. The various inflation zones can be adjusted depending on level and build of gymnasts and apparatus used.

The lower adjusters (A) let you adjust the pit height.

The upper adjusters (B) are for adjusting the pressure and are covered with foam mats in a 20 cm thick jersey casing to guarantee gymnasts comfort. The maximum height above the floor (1.35 m) gives a working height identical to the vaulting table. No longer any need for additional mats.

Inflation is achieved in just a few minutes using an high power fan.



Raised using. Vaulting table example - Height = 1.35 m

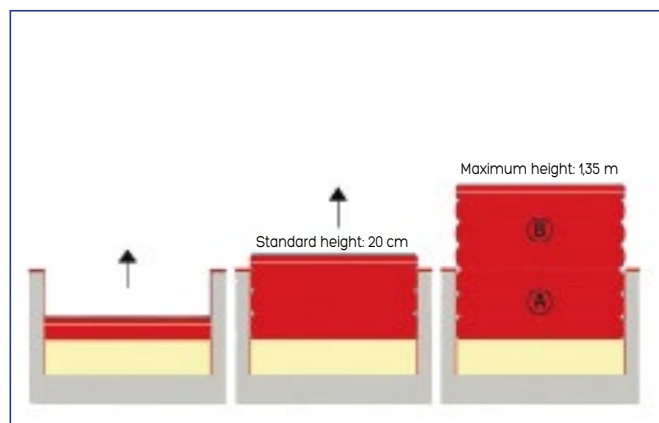

"GIANT SWING" PIT

Ref. 7095 - Enables the coach to spot at floor level and the gymnast to conquer the fear of heights while maintaining visual cues close to the floor. Design on request.



EXTRA SAFETY MAT

Ref. 7012 - Mat to place on top of pit to enhance the cushioning and durability of the pit. PVC underside and stretch jersey top cover.

Dim. = 400 x 200 x 10 cm (Lxwxth).



ACROBATIC SPORTS

BUILT-IN TRAMPOLINES

Specially designed for learning the acrobatic figures used in gymnastics. Metal plates anchored over the entire perimeter in the floor to receive the springs. Supplied with peripheral protection pads, 4 cm thick.

Concrete dimensions and reservation, please consult us.



Ref. 5351

Large size with 13 x 13 mm mesh bed.
Bed dim. = 428 x 214 cm.

Ref. 5352

Identical to Ref. 5351, with pit link.

Ref. 5356

Small size with 13 x 13 mm mesh bed.
Bed dim. = 366 x 183 cm.

Ref. 5357

Identical to Ref. 5356, with pit link.

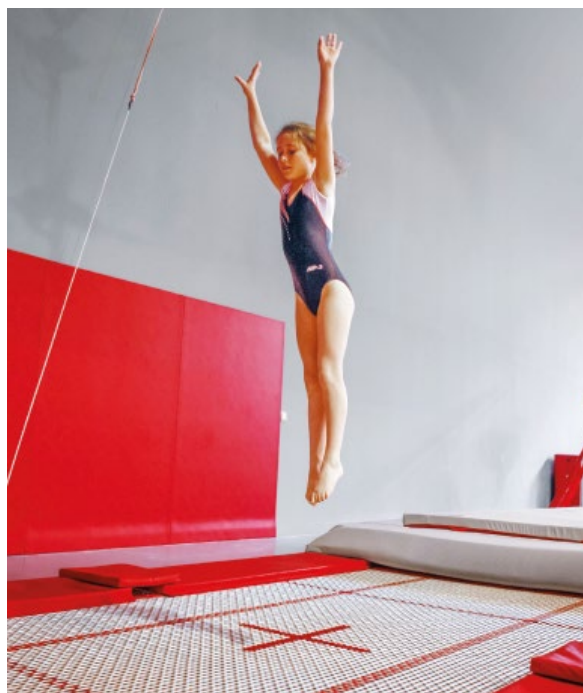

INITIATION TRAMPOLINES



REF. 5080

SALTO TRAMPOLINE

REF. 5080

Initiation trampoline ideally suited to young gymnasts, school use and leisure activities. Rigid struts and holding cables for a better frame stability. Folding feet for low-space storage.

TECHNICAL FEATURES

- Self-assembly frame 374 x 235 cm,
- Height 80 cm,
- 86 cylindrical tempered steel springs
- 3 cm thick protection pads included,
- «Special outdoor» Sportex coated PVC webbing jumping bed 290 x 150 cm for improved durability.

ACCESSORIES

REF. 5082 - Jumping bed. Sportex coated PVC.
Dim. = 290 x 150 cm.

REF. 5084 - Set of 86 springs.

REF. 5086 - Complete peripheral protection pad.
Set of 4.



TRAMPETTES



NEW

TEAM-GYM TRAMPETTES

Acrobatic power and performance!

Team-Gym trampettes with full 4 cm thick peripheral protection including detachable front and rear guards. Steel tubular frame with integrated castors.

Designed for learning and practising jumping exercises, these trampettes give gymnasts a major power boost while still enabling them to work safely on their exercises.

It is easy to transport thanks to its integrated castors and is height adjustable from 65 to 80 cm in increments of 5 cm in accordance with UEG requirements. 6 x 6 mm mesh bed.

Frame dim. = 124 x 124 cm. Weight = 75 kg.

Ref. 5066 "Hard" Team-Gym trampette

Aimed more at the larger build. Distinguishing mark: white dot on the peripheral protection. With 40 springs.

Ref. 5067 "Soft" Team-Gym trampette

Aimed more at the lighter build. With 36 springs.

TEAM-GYM TRAMPETTES ACCESSORIES

Ref. 5068 - Rear guard.

Ref. 5069 - "Hard" model peripheral protection.

Ref. 5071 - "Soft" model peripheral protection.

Ref. 5072 - Set of 40 springs.

Ref. 5073 - Spare 6 x 6 mm mesh bed.



NEW

OPEN TRAMPETTE

Ref. 5052 - Open trampette with 13 x 13 mm mesh bed. Adjustable, multipurpose and dynamic trampette. Quick angle adjustment. 120 x 120 cm tubular frame. Folding angle-adjustable legs. Height adjustment of the front section between 35,5 and 37,5 cm. Supplied with side pads and optional front/rear guards. Tension provided by 32 springs.

OPEN TRAMPETTE ACCESSORIES

Ref. 5043 - Set of front/rear guards.

Ref. 5044 - Set of side pads.

Ref. 5045 - Set of 32 springs.

Ref. 5048 - Spare 13 x 13 mm mesh bed.

TRAMPETTES

Technical features:

- 113 x 113 cm tubular frame.
- Folding angle-adjustable legs.
- Integrated high lift guards.
- 65 x 65 cm jumping bed.
- Integrated castors.

BUNGEE TRAMPETTE

Ref. 5000 - Sportex coated PVC web bed.
Tightened by bungee cords.



SPRING TRAMPETTE

Ref. 5010 - Sportex coated PVC web bed.
Tightened by 28 steel springs.

SUPER SPRING TRAMPETTE

Ref. 5050 - High performance model, identical to Ref. 5010
but with 13 x 13 mm nylon mesh bed.
Tightened by 32 springs.



Tightened by bungee cords



Tightened by springs

TRAMPETTES ACCESSORIES

Ref. 5020

Set of spare bungee cords.



Ref. 5030

Spare Sportex bed.



Ref. 5035

Set of 4 rubber feet.



Ref. 5040

Full set of guards 116 x 116 cm.



Ref. 5055

13 x 13 mm nylon mesh bed.



Ref. 5065

Set of 32 springs.



Discover our inflatable range on page 93



LONG TRAMPOLINES



**Built-in Acrotramp,
please contact us.**

ACROTRAMP

Very effective training aid, helps with learning the technical aspects of acrobatics. Intermediate stage between trampolining and tumbling, facilitates a training system focusing on rebound. Metal frame with Sportex coated PVC webbing bed attached with springs.

Bed height = 53 cm. Overall height (with frame guards) = 60 cm. Frame width = 2.20 m.

Ref. 5360 - Long trampoline. L = 6.70 m.

Ref. 5361 - Long trampoline. L = 12.70 m.

Ref. 5363 - Long trampoline. L = 18.70 m.



Acrotramp with feet.

ACROBATIC TRACKS

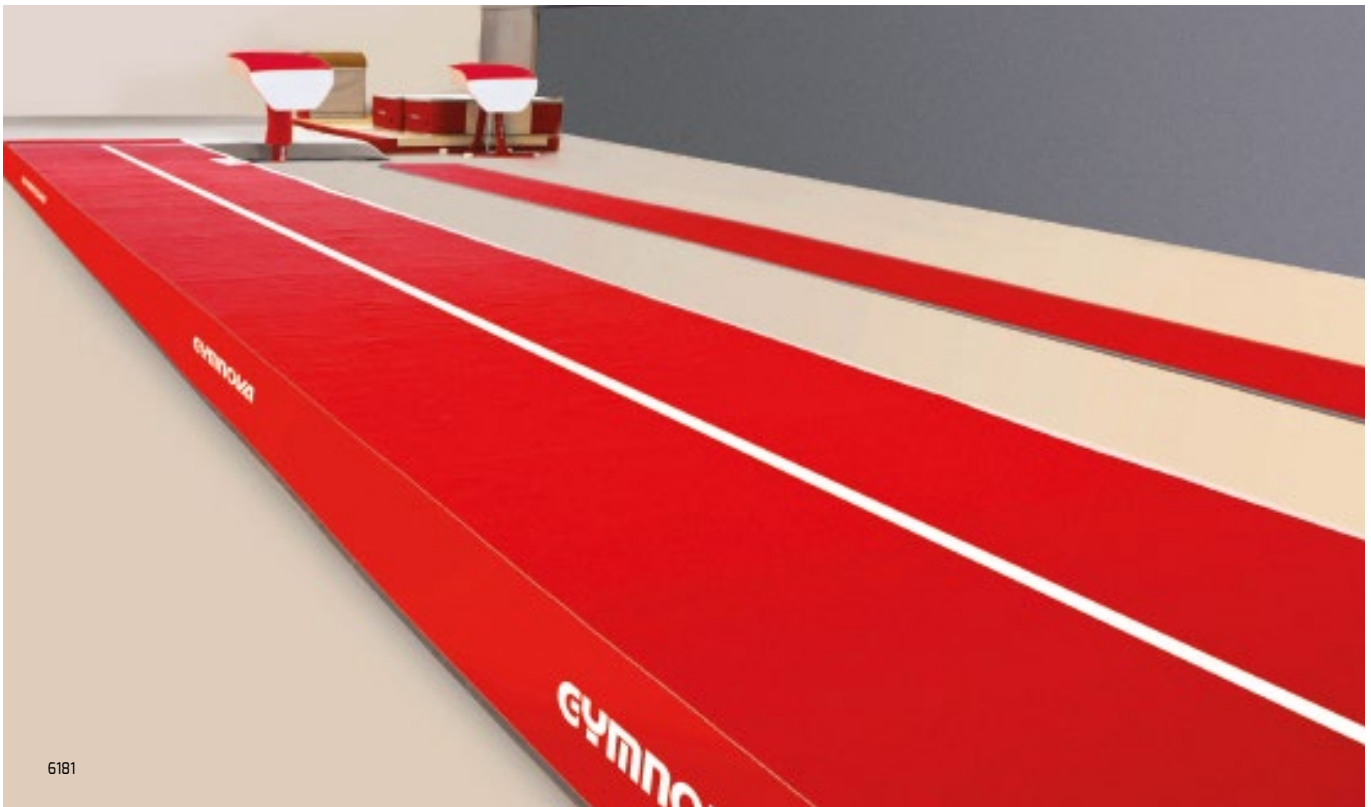

SPRUNG TRACKS

Identical in design to our Competition Sprung Floor Ref. 6576, these tracks offer high comfort, impact absorption on landing and provide exceptionally rebound thanks to the responsiveness of the springs. The impact and strain injuries associated with repeated gymnastic exercises are therefore minimised and the design allows gymnasts to practice the basics on the ground before moving on to a competition sprung floor.

The tracks adapt to gymnasts of all levels while also providing the elasticity needed for pushoffs.

Ideal for intensive training and enable development of routines based on rebound techniques such as flips or twists.

Of identical thickness to GYMNOVA mats and pits (20 cm), these tracks can be joined to those specific products for practicing more complex exercises.

Ref. 6181 Sprung track with roll-up track

Sprung track comprising a roll-up track, 14 interlocking foam panels and 9 high elasticity sprung floor panels with 297 springs in total. Edges are finished with PVC strips attached by hook-and-loop fastener. 50 mm wide beige central strip provides a visual alignment guide.

Dim. = 13.50 x 2 m (lxw) - Thickness = 20 cm*.

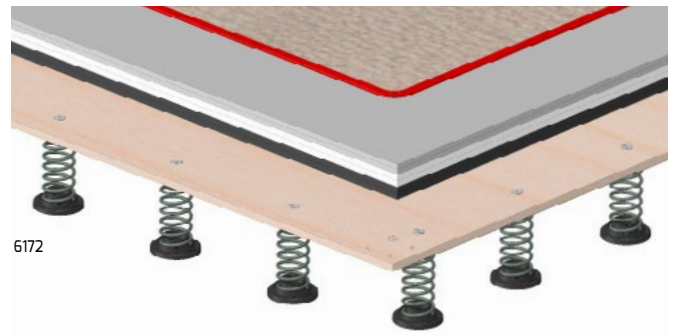

Sprung tracks - "Montreal" version

Sprung Track sections can be linked together to create lengths customisable to your needs (1,5 to 18 m) and your available floor space. The track comprise a tufted carpet layer, interlocking foam panels and high elasticity sprung floor panels with 33 springs. Edges are finished with PVC strips attached by hook-and-loop fastener.

Dim. (panel unit) = 1.50 x 2 m (lxw) - Height = 20 cm.*

Ref. 6171 Sprung track with roll-up track

Identical in design to our Competition Sprung Floor Ref. 6778.

Ref. 6172 Sprung track with covering carpet

Identical in design to our Competition Sprung Floor Ref. 6775. Perimeter of the carpet finished with whip stitching.

***Pit, sprung floor linkage and other dimensions, please contact us.**

ACROBATIC TRACKS



"ACROFLEX " TRACKS

Sprung floor sections with built-in adjustment mechanism, 4 cm deep foam, covering carpet and side skirts. Width = 2 m. Overall thickness = 23 cm. Supplied in 1.50 m lengths. The two types of track, adjustable and non-adjustable, may be used in combination. For example, an 18 m track with a 6 m adjustable section and a 12 m non-adjustable section. For special junctions between tumbling tracks and pits, please contact us.

Ref. 6260 "ACROFLEX" adjustable elasticity track

This track can be adjusted to suit all gymnasts' builds and all ability levels. Due to its design, it contributes to reducing strain injuries due to fatigue during repetitive exercises. Each panel features quick and easy individual adjustment for elasticity, which enables rebound to be modulated over the full 6 m track length.

Ref. 6270 "ACROFLEX" track without adjustable elasticity

6 m length of sprung track. Identical features to Ref. 6260 but without adjustment.

Discover all our inflatable tracks on page 95

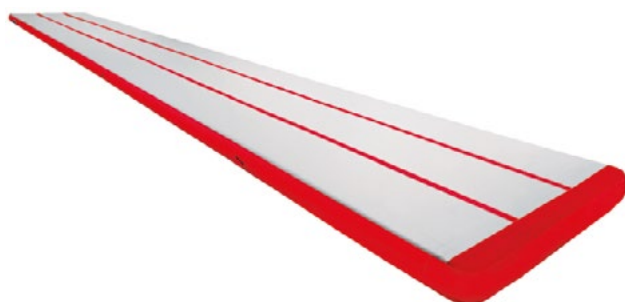

ACROBATIC TRACKS



Our range comprises two acrobatic tracks with virtually the same high elasticity qualities. Linkage is based on the same principle as for our exercise floors.

ACROBATIC TRACK WITH ROLL-UP TRACK

Ref. 6180 - Sprung wooden floor sections with roll-up carpet strip Ref. 6160 (see p. 74). Attached to floor via integrated hook-and-loop strips. No gaps. Dim. = 14 x 2 m (Lxw). Thickness = 14 cm.

FOAM AND CARPET TRACK

Ref. 6186 - Concertina folding foam covered sprung floor sections with separate roll-up carpet. Joins together with hook-and-loop strips. Same degree of elasticity as our gymnastics floor Ref. 6570. No gaps. Dim. = 1.50 x 2 m (Lxw). Thickness = 14.50 cm.

NOTE: supplied with floor anti-rotation kit.

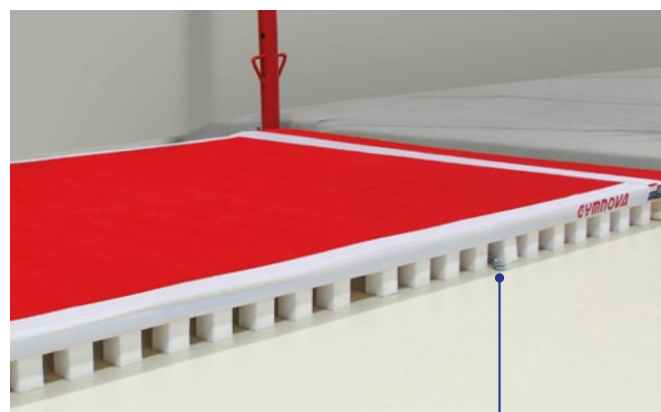

Anti-rotation kit
detail view

TUMBLING

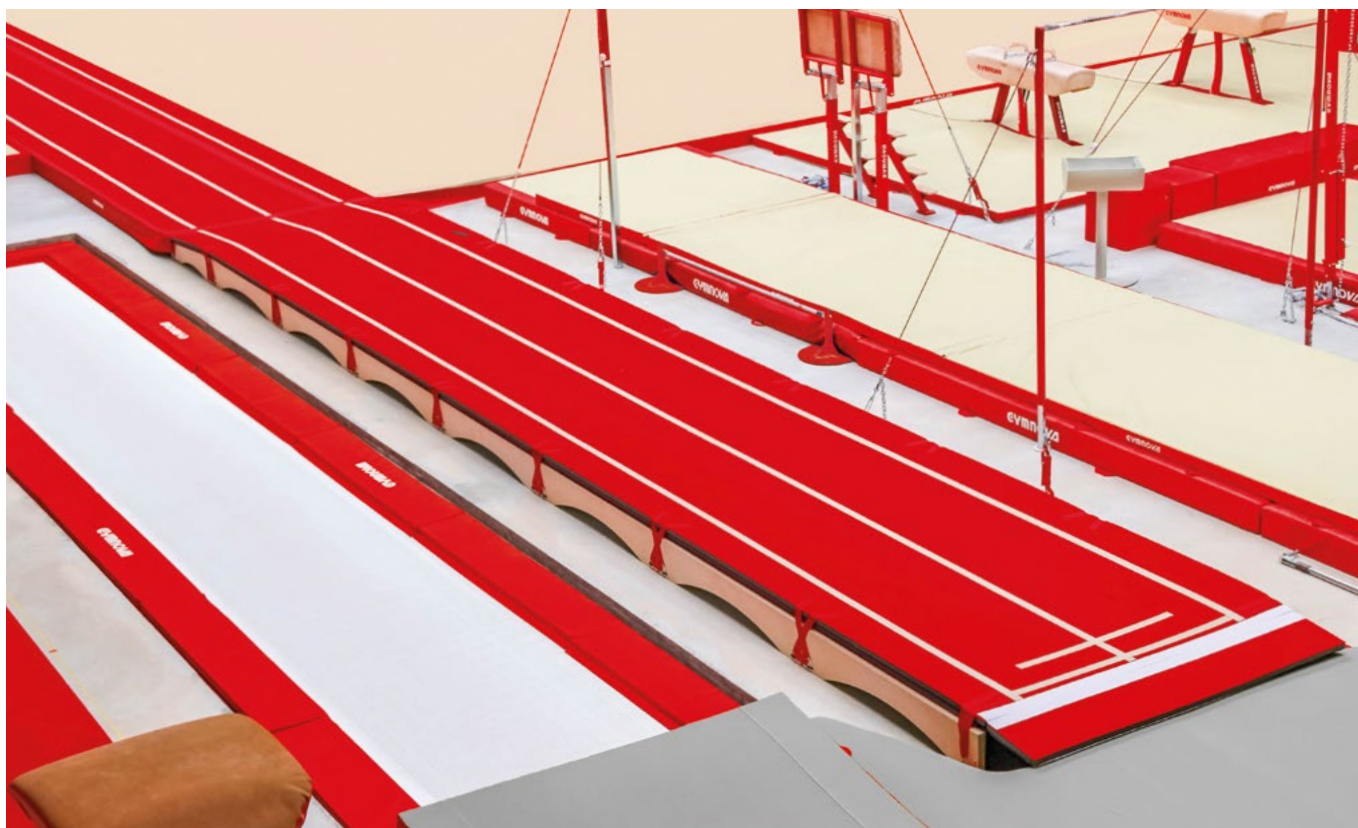

BOUNCY, COMFORTABLE, SILENT, STABLE...

This track provides a dynamic rebound that will allow the development of complex technical skills.

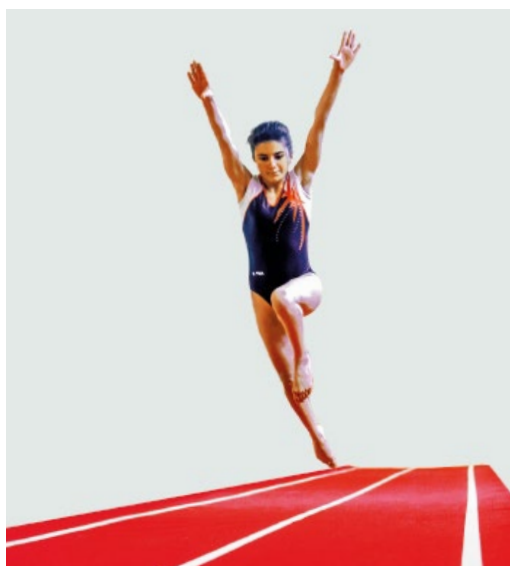

NOVATRACK'ONE



Ref. 6296 - Complete tumble track. Consists of:

- Run-up track, dim. = 10.50 x 1 m (Ref. 6297).
- Tumbling track, dim. = 25.50 x 2 m (Ref. 6298). High-resistant special carpet.
- Landing area, dim. = 6 x 3 m (Ref. 6299), thickness = 30 cm for a safe landing of the tumbler.

If you wish to purchase the items separately, here are the associated references:

Ref. 6297 - Run-up track only.

Ref. 6298 - Tumbling track only.

Ref. 6299 - Landing area only.

Ref. 6299/30 - Additional mat only (optional).





INFLATABLE RANGE

INFLATABLE FLOOR

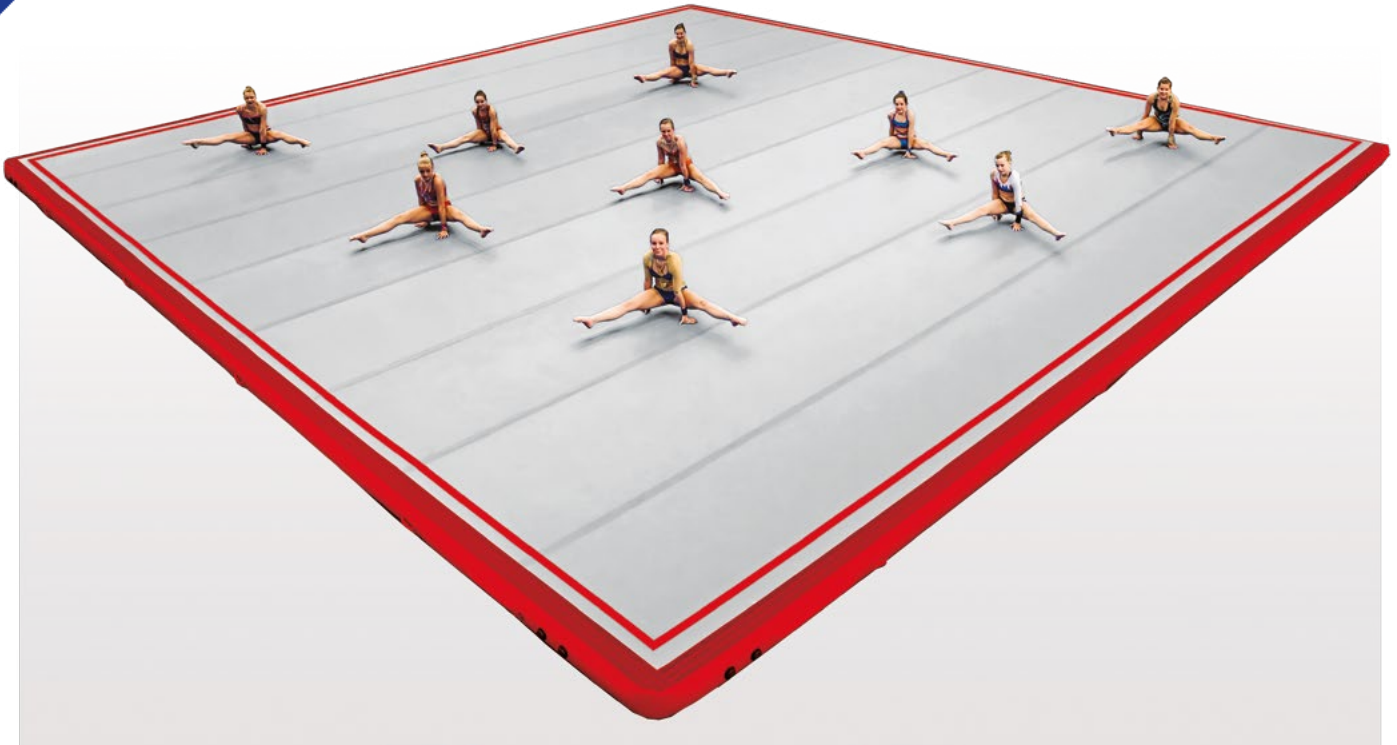

Ref. 6676

This floor, just as your traditional floor, allows your gymnasts to work on a consistent even surface giving stability and precision at point of contact. It provides a very good absorption on landings and helps reducing stresses on wrists and ankles.

The main advantage of this product is its quick installation and deflation. Connect the inflators and your floor is ready for use within a few minutes compared to the average 3-4 hours needed for regular floor set-up. It can be easily stored (folded dimensions of the floor = 153 x 120 x 90 cm (Lxwxth,)) and can be transported in the back of a small van. This inflatable floor establishes itself as the natural first choice for all your workshops and on-the-go demonstrations.

It will remain inflated for the entire duration of your daily training exercises so there is no need to use the inflators during a session. It can also be adapted to any type of exercise and gymnast weight by simply varying the inflation pressure.

Technical features:

- Exercise area marked. Easy to handle once inflated thanks to its 16 handles (4 on each side).
- Peripheral connecting hook-and-loop strips to connect roll-up tracks or foam modules in order to create a larger landing area.
- Easy and quick to inflate thanks to the 4 inflators delivered with the floor.
- The pressure gauge allows adjusting pressure, thus rebound, to adapt to the exercise level, the type of training and/or the weight of the gymnast.
- Dim. = 12.60 x 12.60 m x 20 cm (Lxwxth.). Weight = 435 kg.

Supplied with 4 inflators, 1 pressure gauge, 1 transport trolley and 1 transport cover.

Power requirements: 220 volts. Other power, please contact us.

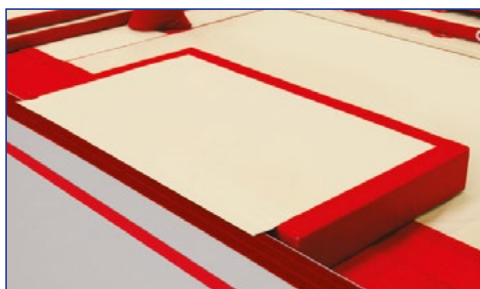

INFLATABLE TRACKS

Allow various assembly combinations to perform acrobatics on a flat working surface while ensuring stability and precision during push-offs. Self-contained, tracks stay inflated for the entire duration of your daily practices, without having to use the inflator. Easy to handle, it is convenient for all type and level of gymnasts from beginners to elite. Easy and quick to set-up and repack.

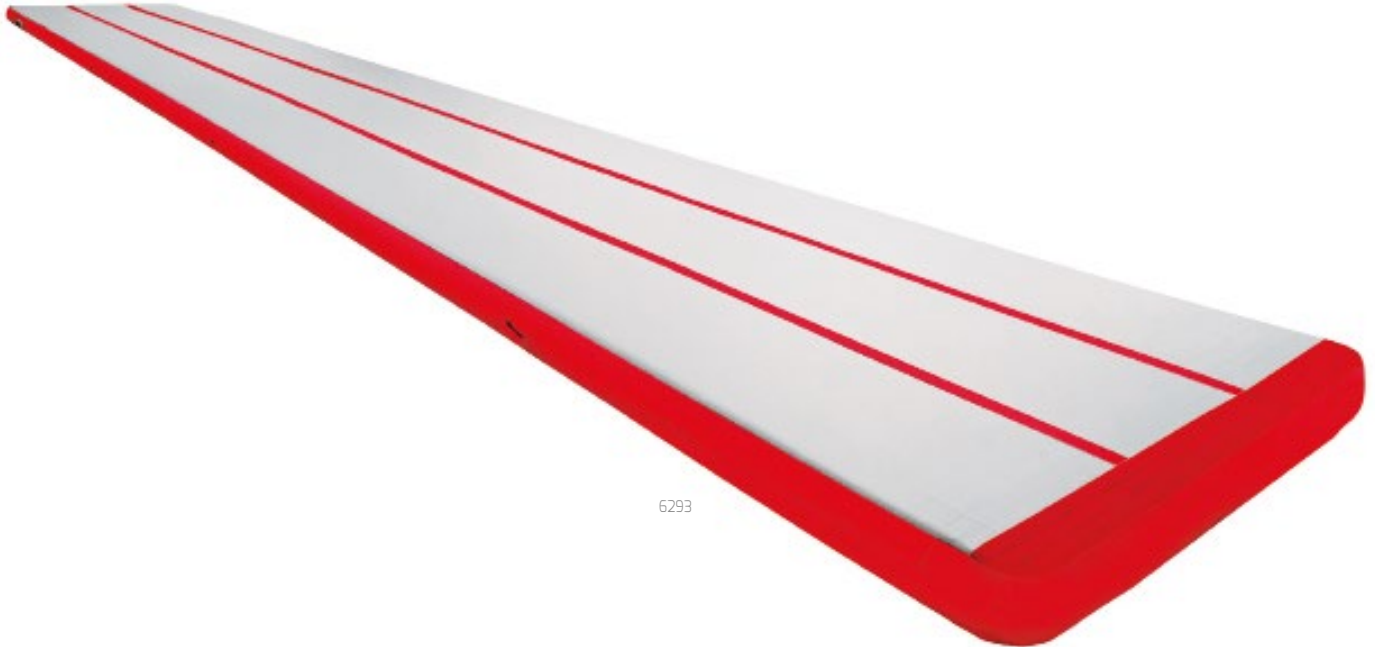

6293

Ref. 6291

Dim. = 1.200 x 180 x 15 cm (Lxwxth). Supplied with 1 inflator, a pressure gauge, a repair kit and a transport cover. 4 carrying handles, 2 valves and hook-and-loop strips across both widths.

Ref. 6293

Dim. = 1.500 x 210 x 20 cm (Lxwxth). Supplied with 2 inflators, a pressure gauge, a repair kit and a transport cover. 8 carrying handles, 3 valves and hook-and-loop strips across both widths.

Ref. 6310

Dim. = 1.000 x 140 x 10 cm (Lxwxth). With 2 valves and self-fixing strips across the 2 widths. It is used more on a surface such as an exercise floor. Comprising 1 inflator, a pressure gauge, a repair kit and a transport cover.

Optional trolley.

Power requirements: 220 volts. Other power, please contact us.



Hook-and-loop strips across both widths



Inflation valve



Digital pressure gauge



Please contact us for made-to-measure inflatable tracks.

INFLATABLE MATS

These easy-to-handle mats protect the training areas quickly in order to reduce the risk of injury. Used as additional mats or as landing mats, they ensure good impact absorption decreasing strain injuries to wrists and ankles.

Assembled with each other using hook-and-loop attachments or straps (not included), they form an actual acrobatic track combining dynamism and stability.

Used on a pit (Ref. 8084 et 8087), gymnasts can also train on hard landings.



REFERENCES	DIM. (Lxwxh)	INFLATION TIME
MATS		
8077	200 x 100 x 10 cm	Between 30 seconds and 1 minute
8081	200 x 100 x 20 cm	
8090	200 x 150 x 10 cm	
8093	200 x 150 x 20 cm	
ACROBATIC TRACKS / PIT MATS		
8084	400 x 200 x 10 cm	Less than 2 minutes
8087	400 x 200 x 20 cm	

Some mats (Ref. 8077 and 8081) have a visual guide in the form of a central line representing the 10 cm standard beam width.

This visual guide will help gymnasts to practise their sequences many of times on a flat surface in complete safety.

NOTE: optional electrical inflator Ref. 8012.



INFLATABLE INCLINED MODULES



These 3 modules with different heights and inclines can be used for daily training on different apparatus or within learning circuits. Thanks to the incline, gymnasts can practise roundoffs and do lots of exercises for strengthening their muscles.

The numbered central line helps the gymnast to quickly spot the impact zones. It also makes it possible to set up a number of gymnastic exercises such as arm push-off.

REF.	DESCRIPTION	DIM. (Lxwxh)	INFLATION TIME
8054	Median inclined module	180 x 120 x 20/30 cm	Between 30 seconds and 2 minutes
8057	Max. inclined module	180 x 120 x 20/65 cm	
8059	Inclined module	120 x 90 x 10/26 cm	



NOTE: optional electrical inflator Ref. 8012.

INFLATABLE MODULES



8071



8062

8065

SPECIFIC VAULTING MODULES

These modules specially developed for vaulting provide significant additional power to allow the gymnast to vault over with no extra effort. Thanks to the markings, the impact zone is clearly visible and helps the gymnasts to position themselves correctly both on the vaulting table and on the springboard. The "impulsion" modules are non-slip. These modules are supplied with fastening straps.

REF.	DESCRIPTION	DIMENSIONS (Lxwxh)	INFLATION TIME
8062	3D push-off square module	95 x 95 x 20 cm	Less than 15 seconds
8065	3D push-off square module	95 x 95 x 10 cm	
8071	3D push-off rectangular module	110 x 60 x 10 cm	



CYLINDRICAL MODULE

This cylindrical module allows working the back inversion and helping to create new psychomotor activities. It is also perfect for core strength exercises.

It can be used alone or along with other elements such as the foam learning beam (Ref. 3665), the covered foam base (Ref. 2125) or the wooden mini-bar (Ref. 0028 - photos below) for practising giant swings.

This module can also be perfectly added to a baby-gym circuit as a teaching hurdle.

REF.	DESCRIPTION	DIMENSIONS (LxØ)	TEMPS DE GONFLAGE
8051	Cylindrical module	106 x 60 cm	Less than 1 minute

NOTE: optional electrical inflator Ref. 8012.



Discover the video



A black and white photograph with selective red coloring. Four individuals are climbing thick ropes in a gym. From left to right: a person in a red jumpsuit with a white and black pattern on the back; a person in a red leotard with black sleeves; a man in a red jumpsuit and white wristbands; and a woman in a red leotard with black sleeves. They are all looking upwards. The background shows a gym structure with a red mat on the floor.

LEARNING AND PHYSICAL TRAINING

BASES and LEARNING ROLLER

Educ'Gym bases are made of wood. They are easily stackable, modules of the same level can be created by stacking one or more bases of different heights. The four sides of the bases have holes for attaching other components of the system via a simple locking or fixing method. They are suitable for teaching and play exercise. They can be combined with wooden mini-bars, learning beams and Educ'Gym benches.

BASES

Ref. 0065 - Dim. = 160 x 40 x 33 cm (Lxwxh).

Ref. 0066 - Dim. = 160 x 40 x 48 cm (Lxwxh).

Ref. 0067 - Dim. = 160 x 40 x 63 cm (Lxwxh).



MINI-BASES

Ref. 0060 - Dim. = 75 x 40 x 33 cm (Lxwxh).

Ref. 0061 - Dim. = 75 x 40 x 48 cm (Lxwxh).

Ref. 0062 - Dim. = 75 x 40 x 63 cm (Lxwxh).



STEP BASES

Ref. 0064 Mini step base

L = 75 cm, 2 heights = 33 and 48 cm.

Ref. 0068 Step base

L = 160 cm, 3 heights = 33, 48 and 63 cm.



LEARNING ROLLER

Ref. 0250 - When fitted between 2 Educ' Gym bases or onto an asymmetric bars hand-rail, the roller can be used to practise forward or backward rotations independently.

Class M1 fire rating stretch jersey cover.

Dim. = 70 x 30 cm (Lxø).



Discover the entire Educ'Gym wooden range on page 112



WALL BARS and ACCESSORIES



SOLID WOOD WALL BARS

Solid wood detachable 17 bars wall bars. Wall bars are great for dynamic, static or core exercises to strengthen muscles in the trunk and upper body. Can be combined with the bench, wall bar projection, muscle-training bench and half bending bar. Fixings sold separately.

Ref. 2315 - 1 person set, L = 83 cm, h = 2.70 m.

Ref. 2325 - 2 person set, L = 163 cm, h = 2.70 m.

Ref. 2335 - 3 person set, L = 243 cm, h = 2.70 m.

Ref. 2345 - 4 person set, L = 323 cm, h = 2.70 m.

Ref. 2355 - 5 person set, L = 403 cm, h = 2.70 m.

Ref. 2365 - 6 person set, L = 483 cm, h = 2.70 m.



MUSCLE-TRAINING BENCHES

These benches, which are adjustable for incline, allow the level of exercise intensity to be set. They are specially designed to build up the muscles required for individual apparatus (closed shoulder angles and open shoulder angles).

Ref. 2261 - Freestanding muscle-training bench.

Ref. 2262 - Muscle-training bench for use on wall bars.

BENCH

Ref. 0045 - This bench is intended for stand-alone use or to be hooked onto wall bars or bases. Dim. = 250 x 23 x 35 cm (Lxwxh). Weight = 18 kg.



REMOVABLE WALL BAR PROJECTION

Ref. 2370 - Extending out from wall bars, useful for working on all types of hanging exercise. If fitted to the lower part of the wall bars (1 m from the floor), it can be used as a ballet bar.

HALF BENDING BAR

Ref. 2372 - Asymmetric foam module with wall bar attachment mechanism. Assists with practising a wide range of different exercises for training abdominal and back muscles. Placed on the ground it can be used for flexibility exercises (work on side splits). Dim. = 90 x 50 x 42 cm (Lxwxh).

BALLET BARRES



BALLET BARRE

Ref. 2220 - Solid wood ballet barre, $\varnothing = 40$ mm.
1.60 m section (bracket not included).

BALLET BARRE BRACKETS

Composite material. They are attached to the wall or on a ballet barre support. Fixings not included.

Ref. 2210 - Single ballet barre bracket.

Ref. 2212 - Double ballet barre bracket.

BALLET BARRE SUPPORTS

Barres not included.

Ref. 2215 - Floor mounted ballet barre support. Height = 1.05 m.

Ref. 2216 - Floor mounted ballet barre support, supplied with single bracket Ref. 2210. Height adjustable from 18 cm to 1.05 m.

Ref. 2217 - Floor mounted ballet barre support, supplied with double bracket Ref. 2212. Height adjustable:

- Low barre: 5 to 85 cm.
- High barre: 25 cm to 1.05 m.



REBOUNDERS AND ROPE RAILS



Mat not included.

REBOUNDERS

Rebounders help gymnasts to practise and improve their presses and planche-to-handstands. They are ideal accessories and are height and distance adjustable, they can be adapted to the gymnast's build by varying the number of bungee cords used. They are ideal for working on half twists, full twists. In the double configuration, they can be combined with mini-apparatus.

Ref. 0135 - Single rebounder.
Ref. 0136 - Double rebounder.



ROPE RAILS

Rails equipped with a linkage system to pull in and out ropes easily. Rope spacing maintained by a chain. Ropes not included, on request. Available in 2 lengths:

Ref. 2230 - Length = 3 m, takes 3 ropes.
Ref. 2231 - Length = 6 m, takes 6 ropes.



2231 2230



TRAMPO-TREMP and VAULT "PUSH-OFF" PADS



TRAMPO-TREMP

Ref. 5090 - Halfway between a springboard and a mini-trampoline, the Trampo-tremp has been developed specially for all learning and working skills of vaulting exercises. Brings to gymnasts a significant gain in power. Its dimensions (= 120 x 98 cm.), close to a standard springboard, mean gymnasts do not need to change their run-up or last take-off point. Easily transportable with integrated moving wheels, it's easily adjustable in height with 3 different positions: 26, 30 and 34 cm. The reinforced "push off" bed is in PVC (dim. = 47 x 74 cm) with central cross marking. The peripheral protective pads are 3 cm thick. Overall tension is provided by 34 springs. Weight = 27 kg.



34 galvanized springs connected to the PVC bed



Height adjustable foot

TRAMPO-TREMP ACCESSORIES

Ref. 5091 - Spare SPORTEX bed.

Ref. 5092 - Complete protection pad.

Ref. 5093 - Set of 34 springs.

VAULT "PUSH-OFF" PADS

Help with practice on second flight and provides additional power. Reduced risk of wrist injury. Special comfort fabric top cover. Metal frame provided with elastic bungee cords.

Ref. 3495 Vault "push-off" pad

Can be used either on the ground or on a vaulting horse. L = 90 cm.

Ref. 3497 Vault "push-off" pad between trampoline and pit

Take-off is performed on the trampoline and landing in the pit. Side retractable, instantaneous locking and unlocking. L = 90 cm.



3495





ROCKING'GYM and ROCKING'ROLLER



ROCKIN'GYM

Available in 3 versions, this new teaching module helps gymnasts to perform back flips and handsprings in complete safety. Due to its unique shaping, the module returns to its initial position after each use and provides proper support for the gymnast throughout each movement.

It has the special feature of automatically rotating when the gymnast's basic jump movements are correct (transfer of bodyweight to the rear).

It enables controlled rotation and provides optimal support while encouraging good flight.

With the use of the stabilisers (sold separately), the Rockin'Gym converts into a mini-vaulting table for teaching the basics of front giants.

Two-tone modules constructed of polyurethane foam and a 1,000 denier PVC cover with M2 fire rating. The modules have fully removable covers and 2 carrying handles for easy transportation and quick set-up. Stabilisers have non-slip base.

Ref. 0350 Rockin'Gym - Mini model

For gymnasts up to 1.30 m tall. Dim. = 78 x 50 x 65 cm.

Ref. 0351 Rockin'Gym - Medium model

For gymnasts up to 1.60 m tall. Dim. = 100 x 70 x 87 cm.

Ref. 0352 Rockin'Gym - Maxi model

For gymnasts over 1.60 m. Dim. = 116 x 80 x 99 cm.

STABILISERS

Ref. 0355 - Stabiliser for Ref. 0350. Dim. = 78 x 50 cm.

Ref. 0356 - Stabiliser for Ref. 0351. Dim. = 95 x 70 cm.

Ref. 0357 - Stabiliser for Ref. 0352. Dim. = 104 x 80 cm.



Medium Rockin'Gym Ref. 0351 with stabiliser Ref. 0356

ROCKIN'ROLLER MODULE

Ideal for early learning of back flips, this teaching aid optimises the coach's work and enables gymnasts to repeat the exercise alone in complete safety. Comprising 3 elements, the set adapts and adjusts along with the gymnast's technique. Length = 70 cm.

Available in 2 dimensions:

Ref. 0375 - ø : 70 cm. Weight: 9,5 kg.

Ref. 0380 - ø : 90 cm. Weight: 15,3 kg.



GYM KUB and MULTI-SHAPE MODULE

WARRANTY
FREE



GYM'KUB

Ref. 0259

This U-shaped module is quick and easy to handle, easily integrated into a Baby-Gym circuit thanks to the tunnel (through, over and under) and is also useful for everyday practice with apparatus. Safe and stable, gymnasts can repeat gymnastic exercises alone in complete safety by positioning the module behind a vaulting table, at the end of a beam, etc.

Comprises:

- 1 tunnel: 200 x 120 x 110 cm (Lxwxh).
- 2 boxes: 100 x 40 x 47.5 cm (Lxwxh).

The components are made of high density impact-absorbing foam fully encased in a 1,000 denier polyester cover and have 4 carrying handles.



MULTI-SHAPE MODULE

Ref. 0260

This set of foam modules can be used to create motor-skill circuits for young children in mini-gym sessions (going through, over and under, with round, square, rectangular and triangular shapes), but also for everyday practice with apparatus. The position of hook and loop strips on each of the elements allow endless possible combinations (end of beam, dismounts off parallel bars, behind vaulting table or push-off pad for second flight practise). May be placed under the beam for safety during practise and allow gymnasts to get used to its height.

Comprises:

- 1 x "U" module: 200 x 150 x 80 cm (Lxwxh).
 - 2 base modules: 200 x 50 x 40 cm (Lxwxh).
 - 2 triangle modules: 100 x 50 x 40 cm (Lxwxh).
 - 2 rectangular block modules: 100 x 50 x 40 cm (Lxwxh).
- Hook and loop fastening system. "Leather look" cover.



Working on second flight

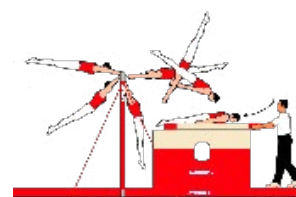

Working on backward dismount
20 cm mat recommended





EDUC'GYM

FOAM MODULES



In a variety of shapes and in some cases with hook-and-loop attachments, these foam modules enable various play activities to be set up to encourage the development of coordination and balance in young children. There is a multitude of possible combinations but the modules can also be used alone or with the wooden range. Designed for children from 18 months to 6 years, they are constructed of polyurethane foam of different densities and are encased in a phthalate-free 1,000 denier PVC cover with M2 fire rating.



INCLINED MODULES

- Ref. 0288 - Dim. = 100 x 70 x 48 cm (Lxwxh).
- Ref. 0360 - Dim. = 100 x 50 x 50 cm (Lxwxh).
- Ref. 0361 - Dim. = 150 x 100 x 60 cm (Lxwxh).
- Ref. 0362 - Dim. = 200 x 100 x 35 cm (Lxwxh).

FOLDING SLOPED PLANES

- Ref. 0289 - Dim. = 200 x 70 x 48 cm (Lxwxh).
- Ref. 0307 - Dim. = 200 x 120 x 30/10 cm (Lxwxh).



VARIO' MODULES

- Ref. 0330 **Beam module.** Dim. = 150 x 30 x 30 cm (Lxwxh).
- Ref. 0334 **Vario'support modules.** Dim. = 60 x 60 x 30 cm (Lxwxh).
Set of 2 elements.



RECTANGULAR BLOCK MODULES

- Ref. 0290 - Dim. = 100 x 58 x 48 cm (Lxwxh).
- Ref. 0293 - Dim. = 70 x 38 x 24 cm (Lxwxh).
- Ref. 0369 - Dim. = 150 x 60 x 60 cm (Lxwxh).



CYLINDER MODULES

- Ref. 0286 - Dim. = 100 x 46 cm (LxØ).
- Ref. 0329 - Dim. = 150 x 30 cm (LxØ).
- Ref. 0366 - Dim. = 150 x 60 cm (LxØ).
- Ref. 0367 - Dim. = 150 x 60 x 30 cm (Lxwxh).



HEXAGON MODULES

- Ref. 0280 - Dim. = 120 x 67/15 x 49 cm (Lxwxh).
- Ref. 0294 - Dim. = 100 x 48/42 cm (LxØ).
- Ref. 0364 - Dim. = 150 x 60 x 26 cm (Lxwxh).
- Ref. 0368 - Dim. = 80 x 38 x 33 cm (Lxwxh).





FOAM MODULES



0287

0363

RAISED WEDGE MODULES

Ref. 0287 - Dim. = 99 x 56 x 45/20 cm (Lxwxh).

Ref. 0363 - Dim. = 150 x 60 x 60/20 cm (Lxwxh).



0298

0306

0331

BRIDGE MODULES

Ref. 0298 - Dim. = 160 x 50 x 80 cm (Lxwxh).

Ref. 0306 - Dim. = 150 x 60 x 75 cm (Lxwxh).

Ref. 0331 - Dim. = 120 x 30 x 60 cm (Lxwxh).



0296

0297

0365

0332

STEP MODULES

Ref. 0296 - Dim. = 76 x 70 x 48/24 cm (Lxwxh).

Ref. 0297 - Dim. = 114 x 70 x 72/48/27 cm (Lxwxh).

Ref. 0365 - Dim. = 150 x 60 x 60 cm (Lxwxh).

Ref. 0332 - Dim. = 160 x 60 x 60 cm (Lxwxh).



0281

HALF CYLINDER

Ref. 0281 Small tall half-cylinder

Dim. = 70 x 39 x 37 cm (Lxwxh).



Ref. 0336 VARIO' TUBES

Set of 3 nesting teaching tunnels to be crossed over or passed through:

- Large module = 100 x 90 cm (ØxL).
- Medium module = 80 x 90 cm (ØxL).
- Small module = 60 x 90 cm (ØxL).



Ref. 0370 DOME MODULE

This dome shaped teaching module is excellent for allowing young children to experience their very first sensations of balance thanks to its rounded, sloping form. For older children the module serves as a rocker when turned over. With 2 carrying handles. Colours: multicolour.

Dim. = 46 x 150 cm (HxØ). Weight = 18 kg.



2121

2122

SPRINGBOARDS

Light and reassuring, they are produced in hard foam with 1,000 denier PVC cover. Ideal for entry onto apparatus.

Ref. 2121 Foam springboard

Colours: blue and yellow. Dim. = 80 x 50 x 20 cm (Lxwxh).

Weight = 4 kg.

Ref. 2122 Large foam springboard

Colours: lime green and yellow. Dim. = 120 x 50 x 25 cm (Lxwxh).

Weight = 5 kg.



Ref. 0371 TUNNEL

As part of a learning sequence it encourages development of motor skills and coordination. Children get to overcome obstacles, learn to roll and crawl... This tool provides multiple play activities. Colours: multicolour. Dim. = 97 x 85/45 cm (LxØ). Weight = 12 kg.

FOAM MODULES



LARGE FOAM MODULES Designed for children between 6 and 12 years.

- Ref. 0262 Large hexagon. Dim. = 160 x 66 x 57 cm (Lxwxh).
- Ref. 0267 Large rectangular prism. Dim. = 160 x 58 x 100 cm (Lxwxh).
- Ref. 0268 Large cylindrical module. Dim. = 100 x 69 cm (Lxø).
- Ref. 0269 Large wedge. Dim. = 160 x 100 x 58/4 cm (Lxwxh).
- Ref. 0270 Large raised wedge. Dim. = 160 x 66 x 65/24 cm (Lxwxh).



MINI FOAM VAULTING HORSE

Ref. 0278 Short half cylinder module
Dim. = 90 x 40 x 20 cm (Lxwxh).

Ref. 0279 Short trapezium module
Dim. = 90 x 60/40 x 60 cm (Lxwxh).



FOAM MODULES ADAPTED

Range of foam modules specially adapted for people with disabilities making gymnastics accessible to all. Inclined section modules, supports and soft mats are constructed of high density foam for increased support. Cylinder modules and steps are made from polystyrene in order to be lighter. Dimensions and foam types that are used have been specially studied to perfectly suit children and adults. PVC cover 1,000 denier, with fire classification M2. Non-slip base. Modules made of foam with different densities from 24 to 120 kg/m³.



Ref. 0340 HANDI CYLINDER

Ideal for learning gymnastics basics: obstacles crossing, forward and reverse rotations (according to disabilities). When combined with supports, it becomes a bridge. With 2 carrying handles. Dim. = 200 x 70 cm (Lxø).



Ref. 0343 HANDI SUPPORT

This module can be used alone to learn crawling or crossing obstacles. When combined with the cylinder module it will allow balance work. Unit. Dim. = 50 x 100 x 50 (Lxwxh).



Ref. 0341 HANDI STEPS

This very stable step allows less abled persons to reach the apparatus easily during educational sessions. With 4 carrying handles. Dim. = 114 x 100 x 72 cm (Lxwxh).



Ref. 0344 HANDI SOFT MAT

Its dimensions will allow you to position it on the Inclined Section Ref. 0342 in order to create a useful angled section for doing rolls exercises. Dim. = 170 x 100 x 10 cm (Lxwxth).



Ref. 0342 RAISED INCLINE SECTION

Thanks to its central opening, users can work on the rolls and be more confident during the descent. The head positioning stays correct during the exercise. This module is used alone or with the Ref. 0345 and 0344. With 4 carrying handles. Dim. = 160 x 100 x 72 cm (Lxwxh). Central opening width = 30 cm.



Ref. 0345 SUPPORT FOAM MODULE

These blocks reduce the width between the raised incline module Ref. 0342 thereby allowing smaller people to do exercises with complete safety. Unit. Recommended quantity: 2. Dim. = 160 x 5 x 66 cm (Lxwxh). Central opening width of Ref. 0342 with optional support foam blocks = 20 cm.



Discover the video

WOODEN RANGE

Manufactured in stained and varnished wood, the ladders are available in 4 models: large and small, straight or curved. They form an interlinking modular set comprising of the various components shown here and enable infinite combinations to be created. They are easy to assemble and adjust and comply with the safety requirements of French standard NF S 54-300 (overturning and stability).



LADDERS



0100

0101

Ref. 0100 Large straight ladder

With 7 rungs. Dim. = 190 x 55 cm.

Ref. 0101 Large curved ladder

Identical to as Ref. 0100 but curved.



0103

0104

Ref. 0103 Small straight ladder

With 4 rungs. Dim. = 111 x 55 cm.

Ref. 0104 Small curved ladder

Identical to Ref. 0103 but curved.



0114

Ref. 0114 Ladder stabiliser

Unit. Absolutely essential, it provides all the stability your kit requires, thanks to its non-slip pads. Supplied with a removable metal bar and thumb wheels.



0115

Ref. 0115 Horizontal joining piece

Unit. Allows the ladders to be fitted together. Comes with 4 thumb wheels and 4 tightening nuts.



0118

Ref. 0118 Ladder assembly pieces

The pair. For fitting ladders together. 4 possible angles for a multitude of different combinations. Supplied with 8 thumb wheels and 8 tightening nuts.

WOODEN RANGE



WOODEN SLIDE

Ref. 0106 - Attachable to ladders.
Dim. = 162 x 55 x 106 cm (Lxwxh).



CLIMBING WALL

Ref. 0108 - Supplied with set of 12 climbing holds. Attachable to ladders. Dim. = 190 x 55 cm (Hxw).

Ref. 0109 - Set of 12 climbing holds. In fun-shaped resin to be fixed on the climbing wall Ref. 0108.



BENCH

Ref. 0045 - Can be hooked onto wall bars or bases.
Dim. = 250 x 23 x 35 cm (Lxwxh). Weight = 18 kg.



WOODEN MINI-BAR

Ref. 0028 - Unit. Hooks onto all bases and mini-bases using a locking system. Dim. = 130 x 4 cm (Lxø). Unit.



SUPPORTING PANEL WITH HOLES

Ref. 0054 - Designed to be fixed to the wall, it saves on stacked bases and accommodates bars, beams and benches using holes similar to those in bases. Fixings not included.
Dim. = 216 x 40 cm (Hxw).



CARPET-COVERED LEARNING BEAMS

Height = 34 cm, width of beam body = 12 cm. Fitted with toggle hooks for attaching to bases or to each other.

Ref. 0041 - L = 2.50 m.

Ref. 0043 - L = 3 m.

Discover the range of bases on page 100

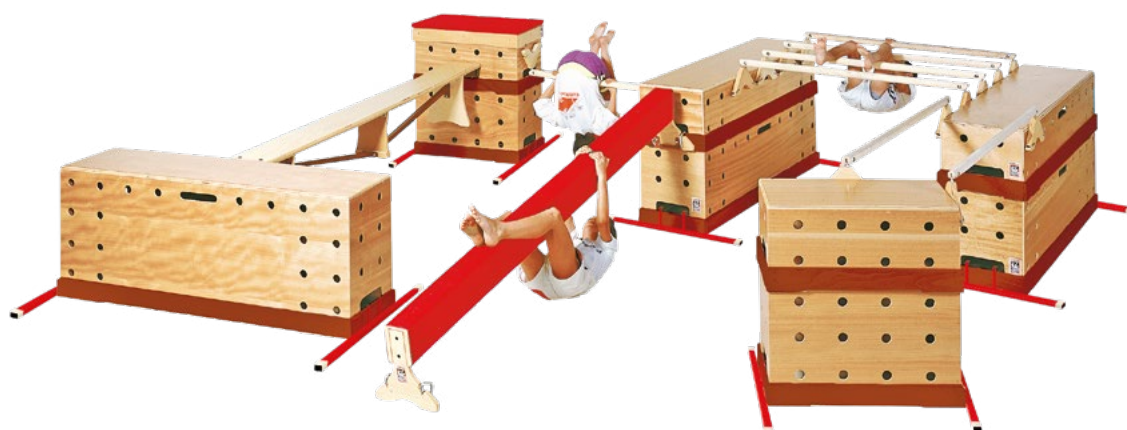

LEARNING MATS



Educ'Gym offers a range of mats perfectly suited to early childhood gymnastics and for making all your learning circuits properly safe. These mats and landing mats are encased in a phthalate-free 1,000 denier PVC cover with M2 fire rating and are made of polyethylene foam.

Ref. 0470 CUBE MAT

When folded, this mat converts to a cube and serves as a valuable teaching tool to be integrated into your Baby-Gym circuits.

Colours: multicolour.

Dim. = 240 x 60 x 5 cm (Lxwxth). Weight = 4 kg.



GYMNASTICS AREAS

These folding gymnastics areas in 50 cm sections are easily installed and stored away. They also represent excellent value for money when acquiring suitable mats for schools. These mats are created using a firm foam.

REFERENCES	DIMENSIONS (Lxwxth)	WEIGHT (kg)	NO. OF COLOURS
0467	200 x 150 x 4 cm	7	3
0468	200 x 200 x 4 cm	9	4
0469	300 x 200 x 4 cm	13	4



FOLDING MATS

They can be folded in 2 lengthwise and they have hook-and-loop strips to be attached to each other. This way, you can create colourful teaching areas. These mats are created using high comfort foam for Ref. 0452 and 0453.

REFERENCES	DIMENSIONS (Lxwxth)	WEIGHT (kg)	COLOURS
0450	200 x 100 x 4 cm	4	GREEN AND YELLOW
0451	200 x 100 x 4 cm	4	BLUE AND PINK
0452	200 x 100 x 10 cm	9	GREEN AND YELLOW
0453	200 x 100 x 10 cm	9	BLUE AND PINK

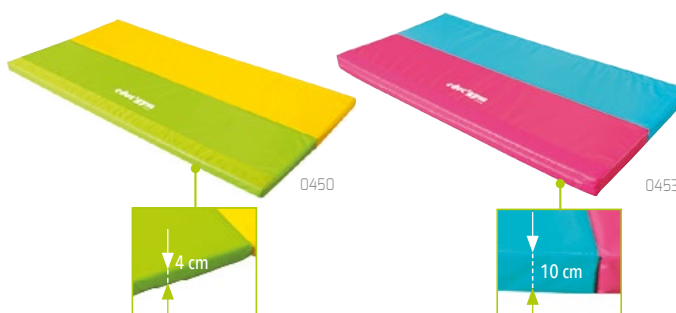

Hook-and-loop fastener mat connection



High comfort foam

Discover the entire "Baby-Gym" range in the Educ'Gym catalogue.





MISCELLANEOUS EQUIPMENT

BELTS and LANYARDS

NEW

HARNESS BELTS

Ref. 2830

Belt with bearings to learn forward and backward rotations. One size fits all, adjustable on a child (from 5 years old) as well as an adult. Equipped with a safety buckle, this belt is adjustable from 55 to 112 cm.

The landmarks (from 1 to 6) allow to refine the adjustment of the belt. The backrest is made of tissue anti-transpiration technology.

Compliant with the resistance standard EN-358: 1999.



NEW

TWISTING BELTS

Belts with ball bearings for performing exercises with twists. Quick and easy to close. Supplied with legs straps.

Ref. 2790 Large model twisting belt

Ø = 38 cm. Waist size from 80 to 110 cm.

Ref. 2795 Small model twisting belt

Ø = 30 cm. Waist size from 65 to 90 cm.



SAFETY BELT

Ref. 2840

Adjustable belt with hooks for attaching long or short lanyards. Fits all waist sizes.

2840



LANYARDS

Ref. 2810

The pair. Spotting lanyards with swivel pins for direct operation by the coach during acrobatics.

2810



SPOTTING RIGS

Provides reassurance to allow gymnasts to develop with confidence. The pulley system allows to reduce the effort required of the spotter. People with lighter builds are able to assist heavier builds.

Technical features :

- Can be fitted to both round (high bar) or square (asymmetric bars) GYMNOVA uprights.
- Offset can be adjusted according to requirements by adapting the length of the cables.
- Special adapter kit for apparatus with access platforms (please enquire).
- No need to fit new anchor points in most instances.

Ref. 2778 Spotting rig for short cables
Floor space = 4 x 2.10 m.

Ref. 2779 Spotting rig for standard cables
Floor space = 5.50 x 4 m.



Learning the straight dismount

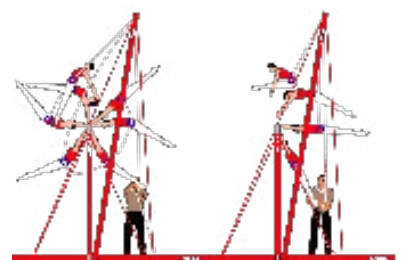

Learning the "Tkatchev"



ACCESS TO THE APPARATUS - SPOTTING

Retractable, they allow access to the apparatus and fold back automatically against it. They are height adjustable and power-assisted.

ACCESS AND SPOTTING PLATFORM

Ref. 2700

Access platform for asymmetric and high bars. Supplied with a platform of 100 x 51.50 cm. Height adjustment from 1,300 to 1,700 mm.

Ref. 2710

Pit-side swivel access platform for rings. Supplied with a platform of 77 x 60.50 cm. Height adjustment from 1,600 to 2,000 mm.

DETACHABLE ACCESS PLATFORM

Ref. 2720

Only fits to GYMNOVA high asymmetric bar uprights. Height may be adjusted.

Smaller platform compared with access and spotting platform (dim. = 77 x 60.5 cm).



COVERED FOAM BASE

Ref. 2125

Hard foam with PVC cover.

Carrying handle.

Dim. = 80 x 50 x 18 cm (Lxwxh).

ACCESS AND SPOTTING BLOCKS

Lightweight and stable, with PVC cover. Allow access to apparatus and can be used to adjust bars.

Ref. 2126 - Dim. = 50 x 50 x 50 cm (Lxwxh).

Ref. 2127 - Dim. = 100 x 70 x 50 cm (Lxwxh).

Ref. 2128 - Dim. = 150 x 60 x 50 cm (Lxwxh).

CHALK and SCOREBOARD

CHALK BOWLS

Ref. 2860 GVA Chalk Bowl

Lightweight, with carrying handle. Facility for the gymnast to attach accessories (sprays, etc.). The half-sphere shaped container reduces chalk dispersal.

H = 82 cm.



2860

Ref. 2861 Chalk Tray for feet

Ideal for applying chalk to the soles of the feet.

Built-in carpet within frame. In polycarbonate.

Inside dim. = 40 x 60 cm.



2861

Ref. 2862 Standard Chalk Bowl

On a pedestal, with wooden stand. H = 75 cm.



2862

CHALK

Ref. 2850 Chalk blocks

3 packs of 8 x 50 g blocks of magnesium chalk.



2850

Ref. 2870 Chalk blocks

36 packs of 8 x 50 g blocks of magnesium chalk.



2870



2851

Ref. 2851 Chalk nuggets

Pack of 12 bags of 350 grs each.

This chalk can be used as nugget or as powder after grinding it. This product has been specially designed for gymnastics use.

SCOREBOARD

Ref. 2600

5 figures scoreboard, complies with FIG standards (scores to thousandth of a point). 2-colour fluorescent display to distinguish decimal places. Board is height adjustable from 1.35 to 2 m and manually operated (operates without batteries or mains supply). 360° rotation.



2600

MISCELLANEOUS



2004

CHEMICAL BEDDING ANCHORS

Chemical fixing with collars and fast setting high strength bedding. Rapid installation in finished floors. Avoids masonry work.

Ref. 2004 - Pack of 4 anchors.

Ref. 2006 - Pack of 6 anchors.

Ref. 2016 - Pack of 16 anchors.

Ref. 2020 - Pack of 2 anchors.

NOTE: can only be used in good quality concrete slabs, thickness 12.5 cm for Ref. 2004, Ref. 2006, Ref. 2016 and Ref. 2020 and 14 cm minimum for Ref. 2000 and slab strength of 23 MPA (megapascals).

RAPID TENSIONER

Ref. 2550 - An essential safety link, it is suitable for all GYMNOVA cable apparatus and enables the apparatus to be quickly adjusted, assembled and dismantled. Unit.

SELF-STABILISING FRAME

Ref. 2751

System using weights to keep the apparatus in place, without fixing it to the floor.

Ideal for all sports halls which cannot take floor anchor points. Can be fitted to all Gymnova apparatus. Guarantees the same stability as a conventional system.

Protective and weights not included (8 x 400 kg required per frame, contact us for information on footprint).

Technical features :

- Floor space = 6.96 x 4.20 m.
- Dimensions at anchor bases = 5.50 x 4 m (complies with international competition).



2000

REMOVABLE ANCHORS

Removable anchors with 360° fold-back rotating hook and removable for maintenance. May be fitted into finished floors.

Ref. 2000 - Unit. Retractable anchor without bedding.

Ref. 2001 - Set of 4 anchors Ref. 2000 with bedding kit.

Ref. 2002 - Set of 8 anchors Ref. 2000 with bedding kit.



2750



2751



PROTECTIONS

GYMUR

Ref. 2451

2 x 1.30 m wall protection panel to protect hazard areas. 24 mm thick. Class M2 fire rating. Red color. Firm polyethylene foam with class M2 fire rating synthetic backing. Supplied without adhesive.

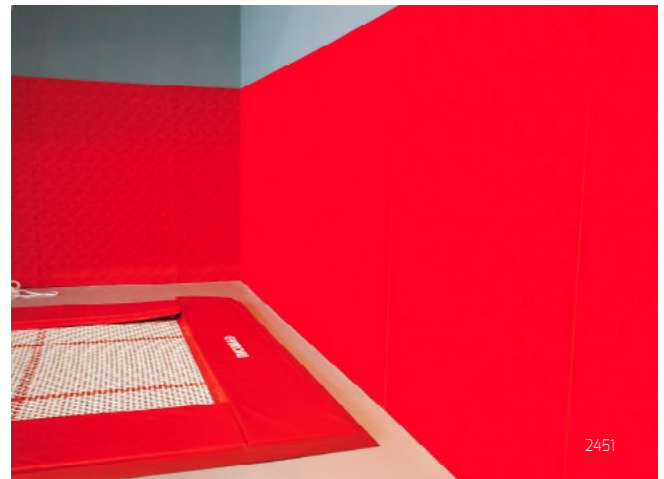

2451

FINISHING MOLDING

Ref. 2464

2 m section. Fix to top or bottom. Gives a neat finish and protects the Gymmur equipment from tears.



REMOVABLE WALL PROTECTION

Ref. 2450

Suitable for all types of flat surfaces. Bonded foam elements, (density = 25 kg/m³) coated with imitation leather fabric with a class M2 fire rating. Adhesive not included. Red color. Dim. = 200 x 100 x 6 cm (Lxwxth).



2450



PROTECTIVE PADS FOR INDOOR AND OUTDOOR POSTS

These protective pads cover both indoor and outdoor posts to make all your sports areas safer. Resistant to humidity and adverse weather.

The protectors are available in numerous colors and can be customized. For variations or specific cut requirements, our design department can draw up specific plans and recommend the solution best suited to your needs.

10 cm thick polyurethane foam protective pads (density = 23 kg/m³) covered with 1,000 denier PVC with a class M2 fire rating held in place by self-gripping flaps. Height: 2 m. Red color.

Ref. 2452 Protective padding for posts

Ref. 2453 Protective U-shaped pads

Ref. 2454 Protective cylindrical pads



2453

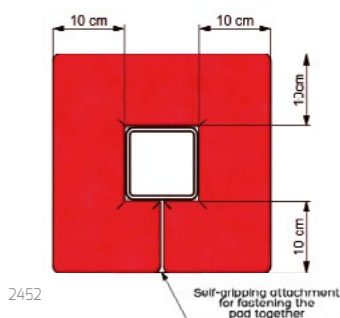

2452

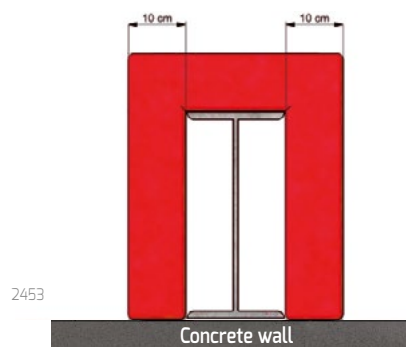

2453

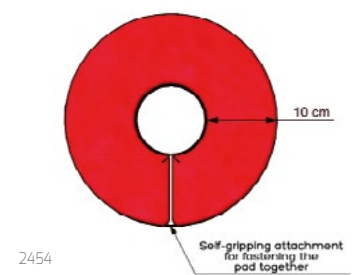

2454

PODIUMS

PODIUM FOR GYMNASTIC AND SPORTING EVENTS

For all your sporting events: artistic, rhythmic or aerobic gymnastics, acrobatic sports, combat sports... Our design office can advise you and create a customized solution for your podiums. Drawing on its unique expertise GYMNOVA has equipped major gymnastics competitions including the Olympic Games, World Championships, European Championships...

Our competition department provides support on your projects and can propose layout solutions to precisely match your needs.

The podium assembly system provides a permanently stable gymnastics surface throughout your event.

All table tops are made of very rigid plywood (thickness = 18 mm) edged with a double-grooved aluminium strip enabling linkage.

The 50 x 50 mm aluminium tubular legs are fitted with non-slip pads.

The standard height of the assembly is 80 cm (non-adjustable) but various heights are nevertheless possible on request: from 12 to 100 cm.

Inspected by Véritas, the product complies with standard NF P 06 001 and Article AM 17 of the regulations on safety in public buildings.

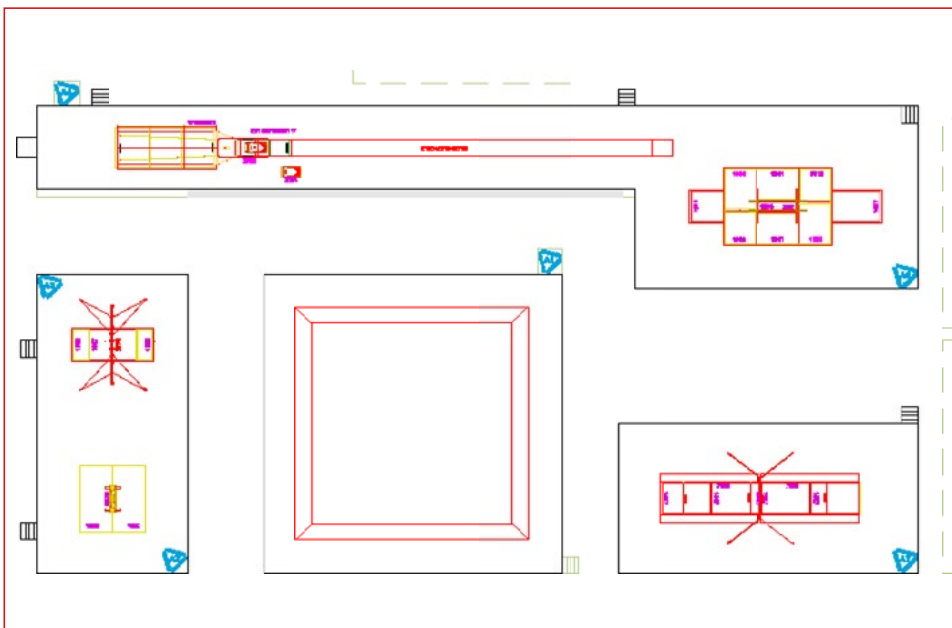

PODIUMS

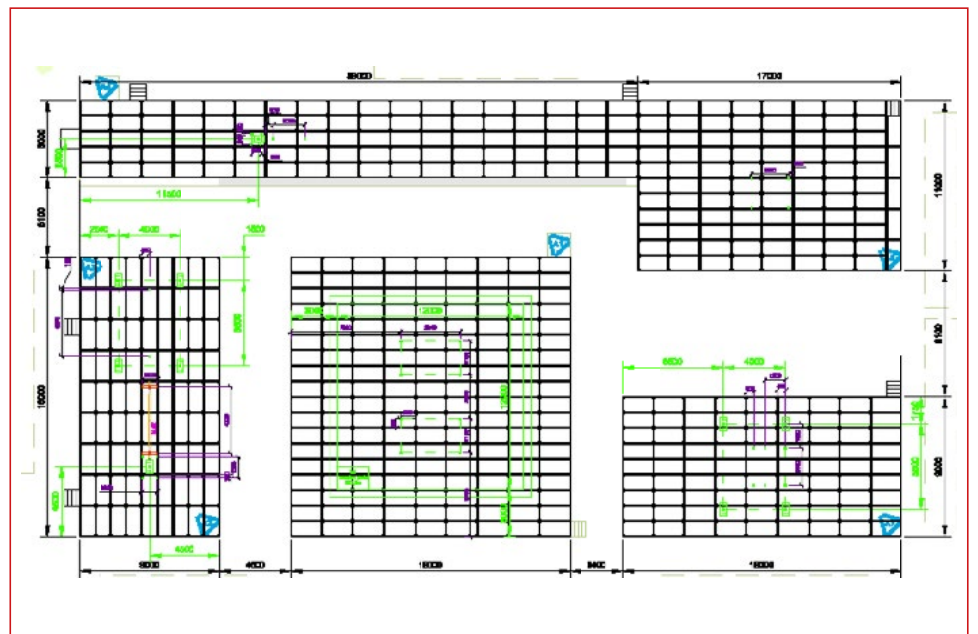
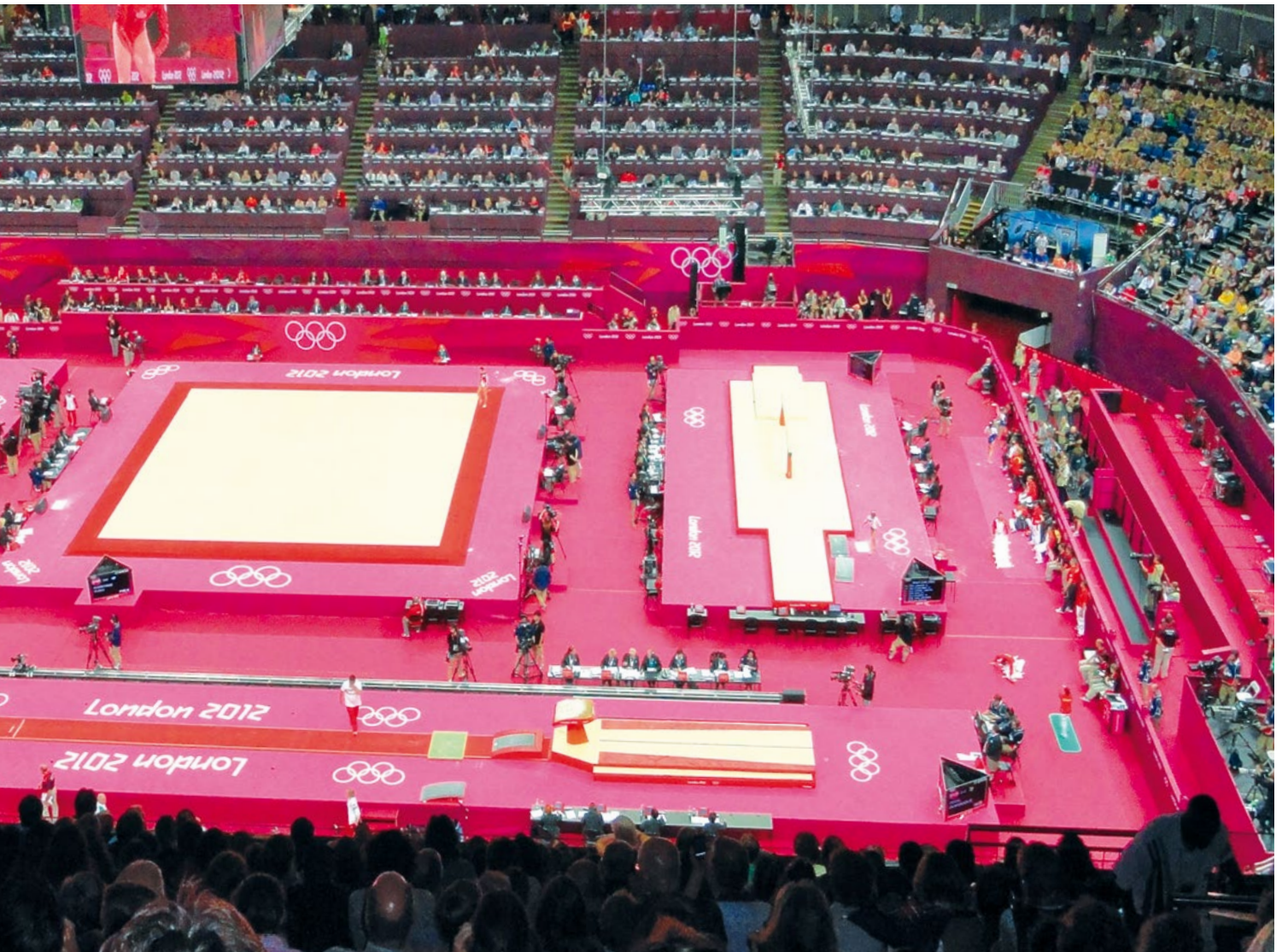

GYMNOVA RESEARCH CENTRE

RESEARCH AND DEVELOPMENT DEPARTMENT

R&D is constantly innovating in order to offer our customers new solutions to suit their needs.

In order to continually anticipate market needs, GYMNOVA keeps an ear to the ground by working closely with the gymnastics world.

Our team of qualified engineers, who all come from the field of gymnastics, have their own testing laboratory in which they carry out internal tests such as resistance calculations, impact tests, puncture tests, etc.

Our products are designed and tested in compliance with current standards.

Putting safety, ergonomics and comfort first.



3D vaulting table

COMMERCIAL STUDIES

Our dedicated department will work with you every step of the way to see your project from design to completion.

Our Research Department has in-depth knowledge of the gymnastics world, the products and manufacturing constraints and is able to design your customized gym with optimum use of space and gymnasts' safety in mind.

We build your project with you, so that we can better identify your needs and fulfil your requirements. With the help of our gymnastics advisers, we offer you tailor-made designs and solutions for items such as pits, wooden frameworks, etc.

We have supplied and installed over 500 specialized sports halls throughout the world!

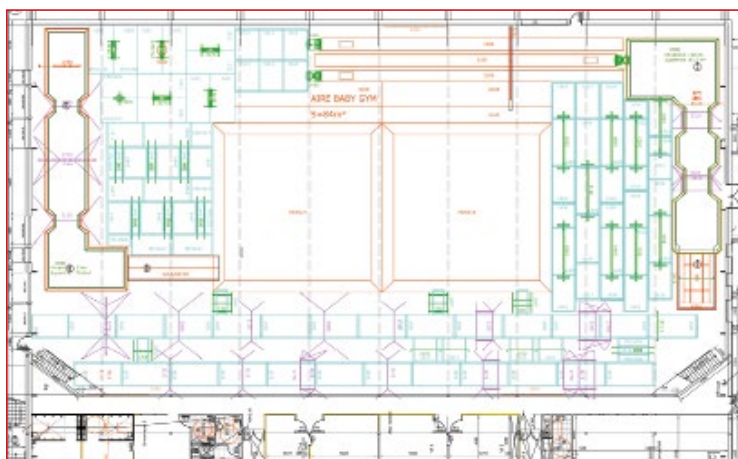

2D gym hall layout



3D gym hall layout

GYMNOVA SERVICES

COMPETITION SERVICE

We have developed a competition service to provide equipment for gymnastic events. A number of FIG-approved (GAM and GAF) apparatus set-ups are available all year round to match the gymnastics calendar.

AFTER SALES SERVICE

GYMNOVA'S After Sales Service is ready to help with all your gymnastics equipment, whether or not under guarantee: our staff are happy to provide information and assistance with any problems you encounter with your equipment. Once we have logged your request, we will do everything we can to identify the causes so that we can implement the appropriate corrective and preventive actions.

MAINTENANCE

Our determination to support the equipment we have created has prompted us to offer you a service dedicated to maintaining your gymnastic facilities and prolonging their service life. This formula, which comprises an inventory of defective parts as well as their replacement by a specialist team, will enable you to fulfil the requirements for sports equipment maintenance.

INSTALLATION SERVICE

Our own teams of technicians, who are specialists in GYMNOVA products, will install your equipment putting your facilities among the best available.



INTERNATIONAL EVENTS

GYMNOVA, OFFICIAL SUPPLIER OF THE FOLLOWING COMPETITIONS:



Artistic Gymnastics World Championships 2017, Montreal (Canada)

2018

- Artistic Gymnastics European Championships, *Glasgow (Scotland)*
- Aerobic World Championships, *Guimaraes (Portugal)*
- Rhythmic Gymnastics European Championships, *Guadalajara (Spain)*

2017

- Artistic Gymnastics World Championships, *Montreal (Canada)*
- Acrobatic Gymnastics World Cup, *Paris (France)*
- Mediterranean Games, *Tarragone (Spain)*
- World Cup, *London (UK)*

2016

- Olympic Games, *Rio (Brazil)*
- Rhythmic Gymnastics European Championships, *Holon (Israel)*
- Aerobic World Championships, *Incheon (Korea)*
- Test-Event, *Rio (Brazil)*

2015

- Artistic gymnastics World Championships, *Glasgow (Scotland)*
- Pan-American Games, *Toronto (Canada)*
- Artistic gymnastics European Championships, *Montpellier (France)*

2014

- Commonwealth Games, *Glasgow (Scotland)*
- South American Games, *Santiago (Chile)*
- Aerobic World Championships, *Cancun (Mexico)*
- Acrobatic Gymnastics World Championships, *Levallois (France)*
- Acrobatic Sports European Championships, *Guimaraes (Portugal)*

2013

- Acrobatic Gymnastics European Championships, *Cantanhede (Portugal)*
- Mediterranean Games, *Mersin (Turkey)*
- Rhythmic Gymnastics World Championships, *Kiev (Ukraine)*
- Aerobic European Championships, *Arques (France)*

2012

- Olympic Games, *London (UK)*
- Aerobic World Championships, *Sofia (Bulgaria)*
- Masculine Artistic Gymnastics European Championships, *Montpellier (France)*

2011

- Acrobatic Sports World Championships, *Birmingham (UK)*
- Rhythmic Gymnastics World Championships, *Montpellier (France)*
- Panamerican Games, *Guadalajara (Mexico)*
- Special Olympics, *Athens (Greece)*
- EYOF, *Trabzon (Turkey)*

2010

- Acrobatic Sports World Championships, *Metz (France)*
- Commonwealth Games, *New Delhi (India)*
- Aerobic World Championships, *Rodez (France)*

2009

- Artistic Gymnastics World Championships, *London (UK)*
- EYOF, *Tampere (Finland)*

Complete list upon request

INDEX

A

Access & spotting platform	51, 118
Acrobatic tracks	89-91
Aerobics	16
Anchors	120
Apparatus	17-62
Asymmetric bars	18-23

B

Ballet barres	102
Beams	24-29
Beam widener	29
Belts	116
Boxes	38
Built-in trampolines	84

C

Cables	23, 61
Chalk	119
Chalk bowl	119

E

Educ'Gym	107-114
Educ'Gym bases	100
Educ'Gym ladders	112

F

Foam modules	108-110
Foam modules adapted	111
Foam protection pads	23, 29, 31, 38, 40, 45, 51, 57, 61
Foam vaulting table	36
Foam vaulting horses	37
Folding mats	69

G

Gymnastics floors	7-15
Guards	23, 28, 31, 34, 38, 40, 45, 51, 57, 61

H

High bars	58-61
-----------	-------

I

Inflatable floor	94
Inflatable mats	96
Inflatable pit	80
Inflatable tracks	95

L

Landing blocks	70-71
Landing mats	64-67
Landing pits	75-80
Lanyards	116
Large trampolines	82-83
Learning roller	100
Long trampolines	88

M

Mats for school	72
Mini-apparatus	22, 48, 56, 61, 62
Multi-shape module	106
Muscle training bench	101
Mushroom	44

P

Parallel bars	52-57
Pommel horses	42-45

R

Rails	22, 57, 61
Rapid tensioner	120
Rebounders	103
Rhythmic Gymnastics	14-15
Rings	46-51
Rockin'Gym	105
Rope rails	103
Runway	31

S

Safety mats	68-69
Scoreboard	119
Self-stabilising frame	120
Spotting rig	117
Springboards	39-41

T

Trampettes	86-87
Transport trolleys	13, 23, 29, 38, 45, 71
Trampo-tremp	41, 104
Tumbling track	73, 74, 92

V

Vaulting area	30-31
Vaulting tables	32-36
Vaulting horses	37-38
Vault push-off pad	35, 104

W

Wall bars	101
Wall protection	121

FIND OUR GENERAL TERMS OF SALE AND OUR ASSEMBLY INSTRUCTIONS ON OUR WEBSITE

WWW.GYMNOVA.COM

The photos in this catalogue are not contractually binding.
 Photo credits: Alan Edwards, Espace Montaigne, Pierrick Jeannotot, Magali Ruffato,
 Anh Viet Chau, Franck Faipot, Thomas Schreyer, GYMNOVA, FIG
 Illustrations: Zen, Gymneo, GYMNOVA
 Design and layout: www.zen-studio.com
 Edition: september 2018





GYMNOVA

CS 30056 - 45 RUE GASTON DE FLOTTE
13375 MARSEILLE CEDEX 12 - FRANCE

TEL. +33 (0)4 91 87 51 20
FAX. +33 (0)4 91 93 86 89

export@gymnova.com
WWW.GYMNOVA.COM

an **ABEO** company