

SPORTS EQUIPMENT





A GYMNOVA BRAND

O'JUMP, a specialist in gymnastics and landing areas, has developed a range of multi-purpose mats and protective surfaces, as well as a range of apparatuses designed for schools including:

Wrestling mats, foam modules, gymnastics mats, mats for climbing walls, protective padding for posts and more... Our expertise enables us to meet all your requirements in terms of both standard and bespoke equipment.

O'JUMP provides solutions for all your sports mat needs from baby gym through to the highest level! Most of our products are available in several thicknesses and can be customised to suit your preferences and requirements (colours, specific dimensions, logos, etc.).

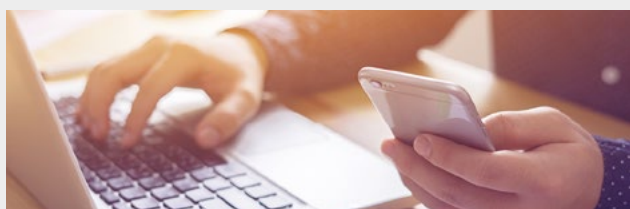

Please do not hesitate to contact us if you require any further information.

+33 (0)4 91 87 51 20
+33 (0)4 91 93 86 89
info@ojump.com

www.ojump.com

Opening times:

- 8:30 a.m. -12:30 p.m. / 1:30 p.m.-6:30 p.m.
(Monday to Thursday)
- 8:30 a.m. -12:30 p.m. / 1:30 p.m.-5:30 p.m.
(Friday)

→ Follow us on Facebook



01 GYMNASTICS

- 06 • Mats for schools
- 08 • Gymnastics tracks
- 10 • Safety mats
- 12 • Landing mats
- 13 • Foam modules
- 17 • Foam blocks

02 PE

- 20 • Asymmetric bars
- 21 • Balance beam
- 22 • Vault
- 24 • High bar
- 24 • Parallel bars

03 URBAN GYMNASTICS

- 26 • Urban gymnastics kit
- 27 • Wedges & Tricking hoop
- 28 • Trapezium & Tricking step
- 29 • Blocks
- 30 • Freestyle training bars

04 ATHLETICS

- 32 • Folding landing areas
- 32 • One-piece landing areas

05 WRESTLING

- 34 • School mats
- 36 • Training mats
- 38 • Competition mats

06 CLIMBING

- 41 • Mats for ACS
- 42 • Mats for bouldering rooms

07 PROTECTIVE PADDING

- 44 • Wall protective padding
- 45 • Protective padding for indoor & outdoor posts
- 46 • Protective padding for team sports
- 47 • Corner padding

OUR COMMITMENTS



• Made in France •

Most of our products are made in our Wattrelos workshops (in the Nord region of France). Covering an area of 4,500 m², these workshops are devoted entirely to the construction of mats and modules using specialist equipment enabling us to offer high-manufacturing quality at extremely competitive prices. The various manufacturing stages are executed in our facility by qualified personnel and the products are assembled on the site. We are thus helping to maintain and create jobs in our country. Our production site is also committed to an environmental approach and we hold ISO 14001 certification.



• Product traceability •

Certain of our products carry a label guaranteeing their traceability. This identification demonstrates our commitment to all our customers in terms of compliance with regulatory requirements and statutory or mandatory information.



• 5-year warranty •

Because we want you to buy with confidence, our entire **O'JUMP** product range benefits from a 5-year warranty* covering material, design and manufacturing faults. Our new design and research & development methods enable us to achieve such a high level of reliability that we are able to offer this guarantee on our full range of products.

* Except for wear and tear parts (hand-rails, meshes, springs...) Please see our General Terms and Conditions for further information.

• After-sales service •

Our after-sales service is here to help you with all your sports equipment both under warranty and out-of-warranty. Our staff provide support for all your maintenance and repair requirements and all these services are carried out directly in our workshops in France. All such operations are recorded and reported to our experts thereby contributing to continuous improvement of product quality.

• A sales team that listens •

Our team can advise you on all your projects. Our sales department listens to your requirements and provides ongoing support to ensure efficient follow-up on your orders, from order confirmation through to delivery and invoicing.



• Customisation •

A specific requirement?

All our products can be customised to meet your needs:

• Custom sizes

• Choice of 8 colors:



• Marking



→ 3 REASONS TO CHOOSE AN O'JUMP PRODUCT

- **SPORTS EQUIPMENT**
for all activities
- **EXPERT ADVICE**
- **FREE ESTIMATES**

PART 1

GYMNASTICS



→ SHOCK-ABSORBENT MATS

Mats that are ideal for use in schools. They can be used separately for warm-ups and stretches but can also be connected by joining the tabs to create gymnastics areas.

Made from ultra-light polyethylene foam (density: 25 kg/m³) with a phthalate-free 1000-denier polyester cover, PVC coated, with class M2 fire rating and anti-slip base. These strong, lightweight mats are easy to set up. Several sizes and colours are available with or without reinforced corners and joining tabs.

Colours available: 

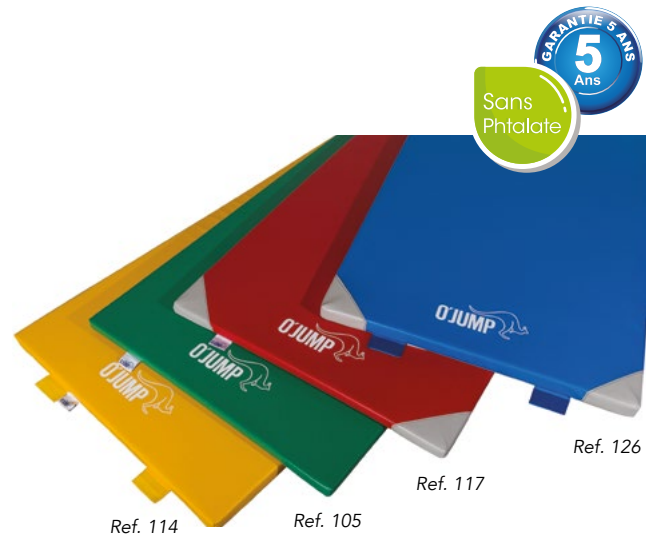

It is possible to create gymnastics areas using the joining tabs.

Ref.	Dim. in cm (LxWxTh)	Weight (kg)	Ref. pack of 3	Ref. pack of 5	Reinforced corners	Joining tabs
105	200 x 100 x 4	5	107	106		
108	200 x 100 x 5.5	6	110	109		
111	200 x 100 x 4	5	113	112		•
114	200 x 100 x 5.5	6	116	115		•
117	200 x 100 x 4	5	119	118	•	
120	200 x 100 x 5.5	6	122	121	•	
123	200 x 100 x 4	5	125	124	•	•
126	200 x 100 x 5.5	6	128	127	•	•

→ MULTICOLOUR GYMNASTICS AREAS



These colourful areas are ideal for play and learning activities.

Foldable into 50 cm sections, they are easy to move and easy to store away. When considering school mats these areas are excellent value for money. Made of 25 kg/m³ firm, lightweight polyethylene foam with a phthalate-free PVC cover with class M2 fire rating and anti-slip base.

Colours: Multi-colour



Ref. 200 - Dim. 200 x 150 x 4 cm (LxWxTh)

Ref. 201 - Dim. 200 x 200 x 4 cm (LxWxTh)

Ref. 202 - Dim. 300 x 200 x 4 cm (LxWxTh)



Ref. 201

Ref. 100 - TRANSPORT TROLLEY FOR HORIZONTAL STORAGE

Ideal for transporting school mats and gymnastics tracks, these trolleys have 4 omnidirectional wheels, 2 of which feature a locking system for easier loading and storage.

Dimensions: 200 x 100 cm (LxW)
Handle height = 79.3 cm. Carrying capacity: 300 kg.

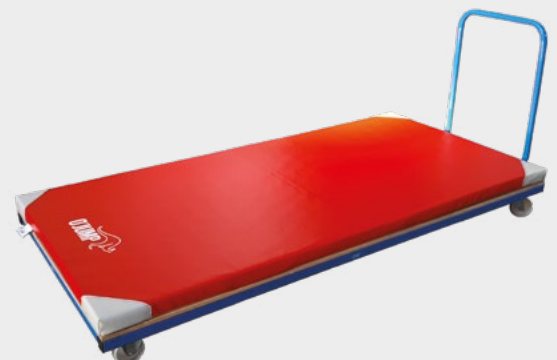

→ FOLDING GYMNASTICS TRACKS

Folding gymnastics tracks are ideal for performing a wide range of gymnastics exercises such as rolls and back walkovers. Some tracks are two-toned, providing users with a visual guide to help them keep a straight course when performing exercises like cartwheels. Sequences such as round-off into flips are possible for more experienced gymnasts. Several tracks have self-gripping strips for creating larger gymnastics areas.

Gymnastics tracks made of ultra-light polyethylene foam (density: 25 kg/m³) with phthalate-free 1000-denier PVC covers with class M2 fire rating.

Colours available: 

Except Ref. 235, only available with a blue central strip and outer strips in the colour of your choice.



Ref. 221



Reinforced corners only Ref. 235



Self-gripping strips



Carrying handles



Ref. 221



Ref. 235

WIDTH 100 cm				
Ref.	Dim. in cm (LxWxTh)	Joinable by means of self-gripping strips	Dimensions when folded in cm (LxWxH)	Weight (kg)
220	600 x 100 x 4	x	200 x 100 x 12	15
221	600 x 100 x 4	Width	200 x 100 x 12	15
222	600 x 100 x 5.5	x	200 x 100 x 18	19
223	600 x 100 x 5.5	Width	200 x 100 x 18	19

WIDTH: 200 cm				
Ref.	Dimensions in cm (LxWxTh)	Joinable by means of self-gripping strips	Dimensions when folded in cm (LxWxH)	Weight (kg)
224	600 x 200 x 4	x	200 x 150 x 16	33
225	600 x 200 x 4	Width	200 x 150 x 16	33
227	600 x 200 x 4	Perimeter	200 x 150 x 16	33
228	600 x 200 x 5.5	x	200 x 150 x 24	43
229	600 x 200 x 5.5	Width	200 x 150 x 24	43
231	600 x 200 x 5.5	Perimeter	200 x 150 x 24	43
232	1200 x 200 x 4	Length	200 x 150 x 32	65
234	1200 x 200 x 5.5	Length	200 x 150 x 48	85
235	1200 x 200 x 5.5	x	200 x 150 x 48	85

→ ROLL-UP GYMNASTICS TRACKS

Tracks are useful for creating gymnastics learning areas in schools. These roll-up tracks are very easy to set up and store away making them suitable for multipurpose sports halls. The anti-slip base prevents the track from moving while in use. Tracks made of ultra-lightweight dynamic polyethylene foam with a needle punch carpet top layer. Three lengths are available: 6, 12 or 14 m.

Colours available: 

Ref.	Dim. in cm (LxWxTh)	Dim. rolled in cm (HxØ)	Weight (kg)
210	600 x 200 x 3.5	200 x 70	24
211	1200 x 200 x 3.5	200 x 100	48
212	1400 x 200 x 3.5	200 x 110	56



Anti-slip base



Tracks may be connected by self-gripping strips to create a training exercise floor (Ref. 213 optional). For example, 7 x Ref. 212 tracks are needed to create a 14 m x 14 m exercise floor.

→ SELF-GRIPPING STRIPS FOR ROLL-UP TRACK

Can be attached directly to the carpet to very quickly create multi-purpose gymnastics areas or a training exercise floor. Width = 10 cm.

Ref. 213 - Length = 25 ml

Ref. 214 - Length = 100 ml

Colours available: 

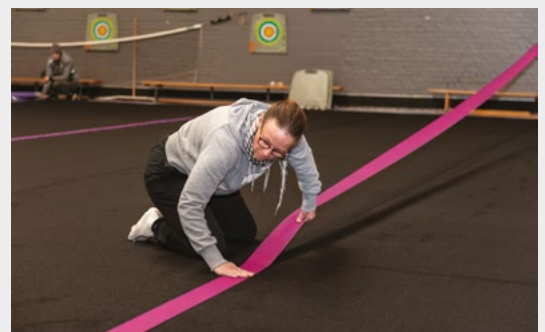

All the landing mats shown are made of polyurethane foam with a phthalate-free 1000-denier PVC cover with class M2 fire rating.

They are available in several sizes and have a non-slip base and carrying handles. They have air ventilation holes around the sides and a zip fastening.



Colours available:

→ MULTI-PURPOSE MATS

Mats specially designed for intensive use. Ideal for use in schools, these mats can be placed under apparatus (beams, bars, etc.) for added safety. They can also be used on floors for practising landings and are easily moved into position using the carrying straps or handles. Certain products (Ref. 307 and 308) have reinforced corners to increase their lifespan.



Ref. 303

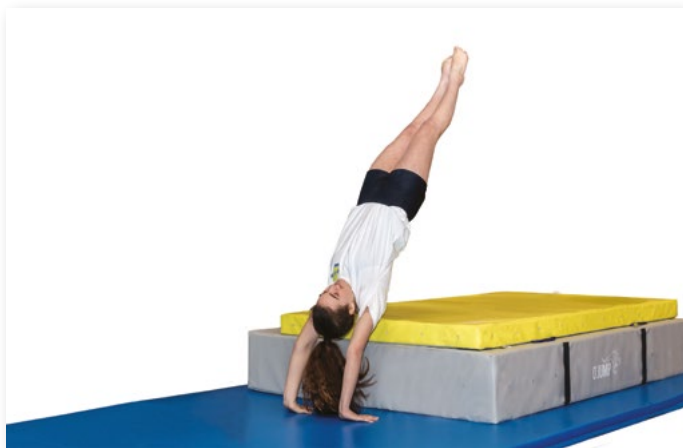

Ref. 307

Reinforced corners*

Ref.	Dimensions in cm (LxWxTh)	Carrying straps or handles	Weight (kg)	Foam density kg/m ³	Ref. cover only
300	200 x 120 x 10	4	11	30	320
301	200 x 120 x 20	4	15	23	321
302	200 x 150 x 20	4	19	23	322
303	240 x 200 x 20	4	28	23	323
304	300 x 200 x 20	4	36	23	324
305	200 x 150 x 30	4	31	30	325
306	300 x 200 x 30	4	45	25	326
307*	300 x 200 x 30	8	45	25	327
308*	300 x 200 x 30	8	54	30	327



Carrying straps for quick and easy set-up.



*Ref. 307 and 308 have reinforced corners.

→ Ref. 310 DUAL-USE FOLDING MAT

This mat's dual function means it can be used both as a landing mat when positioned under apparatus and a single dismount mat when folded. Easy to store and transport with its 2 folding sections and 8 carrying handles. Stitched straps and reinforced corners for multi-use long-term strength.

Size: 400 x 200 x 20 cm (LxWxTh) - Dim. folded 200 x 200 x 40 cm (LxWxTh)
Weight = 39 Kg - Foam density 23 kg/m³.



Folded mat

→ CONNECTABLE LEARNING MODULES

These multi-use modules are intended for athletics and gymnastics in school environments. They ensure good impact absorption on landing and are equipped with 4 carrying handles and connecting straps. Foam density 17 kg/m³.



Ref. 316

The modules can be joined together using the connecting straps to create areas.

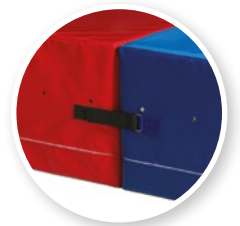

Ref.	Dimensions in cm (LxWxTh)	Weight (kg)	Ref. cover only
315	200 x 100 x 40	19	335
316	200 x 100 x 50	25	336

→ LANDING MATS

Training mats specially designed for gymnastics apparatus.

Compliant with European Standards, they are ideal for low budget clubs economically replacing FIG landing mats. Held in place by hook-and-loop strips eliminates joints to ensure a stable landing with dual density foam.



Ref. 390

Ref.	Dimensions in cm (Lxwxth.)	Carrying handles
390	200 x 200 x 20	4
391	250 x 200 x 20	4
392	300 x 200 x 20	4
393	400 x 200 x 20	8

Landing mats are made from a combination of different density foams, with class M2 fire rating removable 1,000 denier «leather look» PVC covers and phthalate free. Fitted with carrying handles and hook-and-loop connecting strip system (top side) to avoid gaps.



Hook and loop attachment strips on all 4 sides



Complete with Carry Handles and air decompression holes

→ Ref. 399 - SELF-GRIPPING STRIPS FOR LANDING MATS

Directly attached to the mats to create safe surfaces. Width = 20 cm, available in ml.

Information on European standards

Standard NF-EN 12503 sets out a reference framework aimed at protecting the safety of users. The purpose of the standard is to ensure that the conditions of use for school pupils and sports men and women attending sports facilities are as safe as possible. Our European standards compliant mats are recognisable by a compliance identification label.

Especially suitable for schools, early childhood and discovering gymnastics, all foam module products are made of polyurethane foam (density: 23 kg/m³) and encased in a phthalate-free 1000-denier PVC cover with class M2 fire rating. Designed to develop children's motor skills, these modules can be combined with other modules to create learning circuits.



Colours available:



→ HEXAGON



Ref. 069

This module is more stable than a cylinder, helping children develop balance and reduce their fear of heights. It is ideal for obstacle courses. Equipped with 2 carrying handles.

Ref. 068 - Dim. 100 x 50 x 43 cm (LxWxH)

Ref. 069 - Dim. 150 x 60 x 52 cm (LxWxTh)

→ Ref. 064 HALF-HEXAGON



This product can be used as a beam to introduce young children to balance sensations and can be joined to another half-hexagon by means of self-gripping strips.
Size: 150 x 60 x 26 cm (LxWxH)



Possible use created with 2 x Ref. 064.

→ Ref. 066 HALF-CYLINDER



This module is ideal for starting to learn how to do cartwheels. It can be combined with another half-cylinder to create a full cylinder by means of the self-gripping strips on the underside. Size: 150 x 60 x 30 cm (LxWxH)



Possible use created with 2 x Ref. 066.

→ CYLINDER



Ref. 073

This module is ideal for obstacle courses and performing forward rolls. It helps with learning spatial body control. Equipped with 2 carrying handles.

Ref. 071 - Dim. 100 x 50 (LxØ)

Ref. 072 - Dim. 150 x 60 (LxØ)

Ref. 073 - Dim. 100 x 100 (LxØ)

→ Ref. 040 DOME

The dome can be used for learning how to do front and back flips, as an obstacle or combined with other items in a motor skills course. Equipped with 2 carrying handles. Anti-slip base. Size: 60 x 70 x 56 cm (LxØxH)



Ideal for front or back flips.

→ Ref. 053 GENTLE SLOPE WEDGE



With its gentle slope this wedge is ideal for beginning to learn how to do rolls. This product provides effective transition between the wedge and the exercise floor. Equipped with 4 carrying handles. Size: 200 x 100 x 35 cm (LxWxH)

→ WEDGES



Ref. 051

These modules help with learning how to do rolls and feel the speed associated with these movements for the first time. Equipped with a carrying handle.

Ref. 050 - Dim. 100 x 50 x 50 cm (LxWxH)

Ref. 051 - Dim. 150 x 100 x 60 cm (LxWxH)



→ STEP MODULE



Ref. 061



Ref. 062

This module replicates 3 (Ref. 061) or 4 (Ref. 062) steps of a conventional staircase. It teaches young children how to go up and down steps and provides easy access to other modules or apparatus in learning environments. Anti-slip base.

Ref. 061 - Dim. 100 x 50 x 50 cm (LxWxH)

Ref. 062 - Dim. 150 x 60 x 60 cm (LxWxH)

← Possible set up with Ref. 050 and 061.

→ RAISED WEDGE



Ref. 059

These modules are usable as a mini-slide or for learning to do rolls. Children can climb the slope and then stand on the top, helping them manage their fear of heights. Equipped with a carrying handle. Anti-slip base.

Ref. 058 - Dim. 100 x 50 x 50 cm (LxWxH)

Ref. 059 - Dim. 150 x 60 x 60 cm (LxWxH)



→ VAULTING HORSES

Can be used for learning how to vault or combined with other items in a motor skills course.

They are made up of several modules and can therefore be adapted various sizes of gymnast and used to create a variety of different obstacles. Equipped with 2 carrying handles and anti-slip base.

Ref. 077 - 4-piece horse



Comprising of the following items:
 - 1 base module (height: 70 cm)
 - 2 intermediate modules (height: 20 cm)
 - 1 half-cylinder (height: 30 cm)

Overall dimensions: 150 x 80/50 x 140 (LxWxH)

Ref. 079 - 2-piece horse



Comprising of the following items:
 - 1 base module (height: 70 cm)
 - 1 half-cylinder (height: 30 cm)

Overall dimensions: 150 x 80/50 x 100 (LxWxH)

→ ONE-PIECE BLOCKS

Ideal for introducing jumping. Equipped with 2 carrying handles and imitation leather base.

Ref. 055 - Dim. 100 x 50 x 50 cm (LxWxH)

Ref. 056 - Dim. 150 x 60 x 60 cm (LxWxH)

Ref. 075 - Dim. 160 x 80 x 100 cm (LxWxH)



Ref. 075



Ref. 056



→ Ref. 085 MULTI-BLOCS



Made up of 6 stackable elements, this versatile module offers several different heights.

Composition :

- 3 blocks dimensions 60 x 40 x 20 cm (LxWxH)
- 2 blocks dimensions 60 x 60 x 20 cm (LxWxH)
- 1 block dimensions 60 x 120 x 20 cm (LxWxH)

The modules can be dissociated and used separately.

Overall dimensions: 60 x 120 x 60 cm (LxWxH).
Only available in red.

EXAMPLES OF TEACHING CIRCUITS



PART 2

PE



→ Ref. 670 **PE ASYMMETRIC BARS**

NEW



Freestanding compact asymmetric bars with laminated fiberglass hand-rails. These have been specially designed for school PE and club practice.

Hand-rails height adjustment has been made easy by offsetting the handles.

- Low hand-rail adjustable from 140 to 170 cm
- High hand-rail adjustable from 215 to 245 cm

Technical features:

- Bar width adjustable from 60 to 140 cm
- Length of the hand-rails: 240 cm
- With anti-sliding rubber feet
- Integrated transport castors
- Floor space: 2.52 x 2.05 m (LxW)
- Weight: 187 kg

NEW

→ **LOW HAND-RAILS**

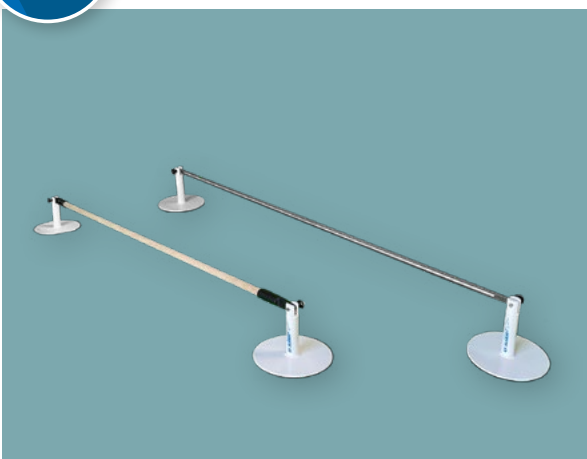

Easy to transport and perfect for training, they allow for the reinforcement of various hand supports.

These steel-made supports offer great stability. Allowing space to add a 20 cm mat in order to provide a safe training area.

Two available models:

Ref. 672 - Low wooden asymmetric bars hand-rail

Ref. 692 - Low steel high bars hand-rail

Technical features:

- Hand-rails length: 180 cm
- Floor space: 212 x 32 x 27 cm (LxWxH)

NEW

→ **HAND-RAILS ONLY**

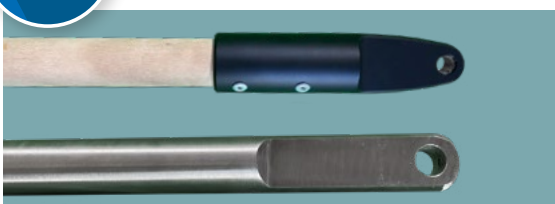

Adjustable to Ref. 690 high bars, the low hand-rails Ref. 672 and 692 as well as to the freestyle complete set (see page 28). Length of the hand-rails: 180 cm. Per unit.

Ref. 673 - Wooden asymmetric bars hand-rail. Ø = 40 mm.

Ref. 693 - Steel high bars hand-rail. Ø = 28 mm.

→ Ref. 680 ADJUSTABLE FROM GROUND BALANCE BEAM

This balance beam with standard dimensions is perfect for training and allowing work both at ground level and adjusts to FIG height whilst providing stability and rebound of a traditional beam.

Height adjustment can be made without moving either mats or feet of the beam in order to adapt to the child evolution.

Technical features:

- Dimensions: length 5 m - width 10 cm
- Adjustable height from 50 to 125 cm with 5 cm Increments
- Comes with anti-sliding cover and rubber feet
- Soft foam end caps



◀ Adjustable in height



→ LOW BEAMS

Perfect for making first steps into gymnastics, this low level beam gives the gymnast confidence due to a height of (40 cm).

Its anti-slip cover and width (10 cm) are identical to that of the standard beams therefore providing a similar experience.

It is possible to place a safety mats underneath for safe training.

Available in 2 lengths:

Ref. 681 - Length 3 m

Ref. 682 - Length 5 m



Ref. 681



◀ Soft foam end caps



→ Ref. 699 BUCK

Ideal for learning jumps. This leatherette covered buck is an essential educational tool for introduction level and the School and club environment.

Technical features:

- Height adjustment from 94 to 134 cm with 5 cm increments
- Body dimensions: 60 x 35 x 28 cm (LxWxH)
- With anti-sliding rubber feet



Designed specifically for gymnastics, blocks can be used for both introductory and more advanced sessions involving jumping movements in schools.

All the PVC modules are made of polyurethane foam with a phthalate-free 1000-denier cover with class M2 fire rating.

Each module has self-gripping strips for easier positioning. The anti-slip base on the modules makes it possible to use them separately in a number of learning situations.

Colours available:



→ TWO-PIECE BLOCKS

Blocks specifically designed for physical education & sport suitable for use by school students from 11 to 18 years. These modules are very stable when performing different holds. Imitation leather cover identical to the vaulting table for the upper module of Ref. 076.

They are made up of 2 components:

- 1 base module 80 cm in height
- 1 upper module 20 cm in height

Ref. 074 - Dim. 160 x 80 x 100 cm (LxWxH)

With PVC upper module

Ref. 076 - Dim. 160 x 80 x 100 cm (LxWxH)

With imitation leather upper module.

Dual-density foam.



Ref. 074
red



Ref. 076
black



Ref. 076
grey



→ Ref. 685 **SPRING PE TRAMPETTE**

Both dynamic and secure, this trampette is perfect for learning and practicing jumping exercises. Its tubular steel frame (dim. 113 x 113 cm) can easily be tilted and adjusted to different heights.

It is fitted with integrated moving castors and a complete with 3 cm thick frame protection pads. 65 x 65 cm nylon bed mesh with represented impact zone marking and tightened by 28 steel springs.

Its feet are equipped with anti-sliding rubber and can be folded for easy storage.

Weight = 36 kg.



◀ Tightened by springs

→ **COMBINABLE BLOCKS**

Height adjustable from 20 cm to 120 cm, with these modules you can adapt your circuits to the users' level and to learning situations.

You can also choose the colour and height (40 cm or 20 cm) of each module (except Ref. 084).

Construct your foam blocks and adapt your sports sessions to your needs!

POSSIBLE CONFIGURATIONS:



Sample circuit created with
1 x Ref. 080, 1 x Ref. 081,
1 x Ref. 082 and 1 x Ref. 303.



Ref.	Descriptions	Dimensions in cm (LxWxH)	Foam densities (kg/m3)	Specific features
080	A Module de base	160 x 60 x 40	23	Fitted with 2 carrying handles
081	B Intermediate module	160 x 60 x 40	23	/
082	C Intermediate module	160 x 60 x 20	23	/
083	D Upper module	160 x 60 x 20	30	Imitation leather
084	E Upper module	160 x 60 x 20	23	/

NEW

→ Ref. 690 PE HIGH BAR



Ideal for training gyms, this type of bar is cableless. Specially designed for learning purposes, the height can be easily and quickly adjusted from 45 to 200 cm in 5 cm increments.

It comes with a high bar hand-rail (L=1.80 m) and with an integrated sleeve for straps.

Floor space: 220 x 25 cm.

To be anchored into the ground, anchors are not supplied.



NEW

→ Ref. 695 LOW PARALLEL BARS



These low easy to transport parallel bars are ideal for training and physical preparation based on body weight. Stable structure for an easier hand displacement thanks to its anti-sliding feet.

Ø 38 mm steel tube.

Dimensions: 190 x 100 x 60 cm (LxWxH).

Weight: 34 kg.



Ref. 950

→ Please see page 28 for our training bars.

PART 3

URBAN GYMNASTICS



O'JUMP 

O'JUMP

O'JUMP 



O'JUMP has developed a new range of foam modules designed specifically for urban gymnastics and to meet the requirements of specialised structures.

Each module has been carefully developed in collaboration with a number of urban gymnastics clubs so that users can express their creativity in complete safety.

All the modules in the range represent obstacles found in the urban or natural environment. The modular nature of the range enables you to construct a variety of obstacles and circuits for each session.

The modules are distinct and can be used separately. They have carrying handles and an anti-slip base (except Ref. 911 & 912). The modules are made of dual-density foam and a phthalate-free 1,000-denier PVC cover with class M2 fire rating.



→ Watch the video

Ref. 940 - COMPLETE KIT

Includes all the modules needed for practicing urban gymnastics. The kit comprises the following references:



TRICKING HOOP
Ref. 900



WEDGE
Ref. 910



TRAPEZIUM & STEP
Ref. 920 & Ref. 925



BLOCKS
Ref. 930

→ WEDGES



Ref. 912

Ref. 911

These 2 wedges form an essential part of any obstacle course. They have been created to simulate slopes generally encountered in the urban environment with different inclines. They are ideal for teaching both downward and upward movements such as jumping from height and certain acrobatic movements. They can be used flat on the ground or vertically to simulate crossing over a wall. Moves such as kicks and flips are easy to perform on these modules.

Ref.	Description	Dim. in cm (LxWxH)	Ref. 910
911	Medium wedge	200 x 100 x 60/15	Set of 2 wedges (Ref. 911 + Ref. 912)
912	Large wedge	200 x 100 x 90/15	

→ TRICKING HOOP



Ref. 900

Take your training to a whole new level!

Ref. 900 - The tricking hoop module adds a fun aspect to performing and the challenge of trying out new tricks. The circular shape is a key element for preparation exercises in the urban gymnastics environment encouraging users to anticipate manoeuvres in narrow spaces and improve precision of movement.

Dimensions: 160 x 50 cm (ØxTh) - inside Ø: 1 m

→ TRAPEZIUM AND TRICKING STEP



The Trapezium (**Ref. 920**) is made up of 3 modules allowing a variety of heights: 50, 100, 150 cm. These components are securely joined together by means of self-gripping strips but can also be used separately to create different kinds of obstacles.

The Trapezium module (**Ref. 920**) and the Tricking Step module (**Ref. 925**) can be combined to create an obstacle measuring 1.80 m in height.

They are especially suitable for working on cat leaps. The bevelled edges also make it easier to learn movements where the push-off is directly on the obstacle (360, wall flip, tic-tac, etc.).



Ref. 920 + 925

Ref.	Description	Dim. in cm (LxWxH)	Ref. 920
921	A Upper trapezium module	150 x 70/40 x 50	Complete trapezium module Comprising Ref. 921, 922 and 923. Overall dimensions = 150 x 130/40 x 150 cm (LxWxH)
922	B Intermediate trapezium module	150 x 100/70 x 50	
923	C Lower trapezium module	150 x 130/100 x 50	
925	D Tricking Step module	150 x 40 x 30	

→ **BLOCKS**

A number of scenarios can be made using these 3 modules construct your urban environment use the modules to make walls, bridges and other obstacles. The modules have carrying handles and self-gripping strips so that you can easily combine them to create obstacles to be crossed. Used together, they can also form steps or low walls. They are very easy to store and transport.



Ref. 933

Ref. 931

Ref. 932

Possible heights if you assemble the 3 modules:
70, 90, 100 or 130 cm.



Ref. 930



Ref.	Description	Dim. in cm (LxWxH)	Ref. 930
931	A Small Block	120 x 60 x 30	Set of 3 Block modules Comprising Ref. 931, 932 and 933. Overall dimensions = 120 x 60 x 130 cm (LxWxH)
932	B Medium Block	120 x 60 x 40	
933	C Large Block	120 x 60 x 60	



→ **FREESTYLE TRAINING BARS**



Ref. 950

This complete set of training bars is a real obstacle course that will allow you to practice exercises individually or as part of a circuit. The bars can be adjusted in height according to your requirements.

Technical features:

- Cableless bars without requirement for any supporting cable. To be anchored into the ground.
- *Anchors are not supplied but available for this item*
- Rails adjustment from 25 to 175 cm with 5 cm increments.
- Hand-rails length= 180 cm.

Ref. 950 - Complete set of freestyle training bars fitted with 4 hand-rails (2 steel ones and 2 wooden ones).

Ref. 951 - Post with 4 uprights

Ref. 952 - Wooden hand-rail with lateral upright

Ref. 953 - Steel hand-rail with lateral upright

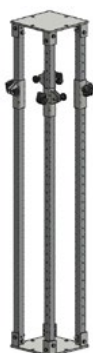

Ref. 951



Ref. 952



Ref. 953



Please feel free to contact us for your specialized gym projects. Protective pads for posts, landing mats, landing blocks: we will be happy to help you design the made-to-measure products of

PART 4

ATHLETICS



LANDING AREAS FOR SCHOOLS

A range of landing areas specifically designed for physical education & sport. These products are made of polyethylene foam (density: 17 kg/m³) with phthalate-free 1,000-denier PVC covers with class M2 fire rating. They feature an anti-slip base.



Colours available:

→ FOLDING LANDING AREAS

These are folding 3-section landing areas and are equipped with 4 carrying handles for easier storage and handling.



Optimised storage



Ref.	Dim. in cm (LxWxTh)	Dim. folded in cm (LxWxTh)	Weight (kg)
400	400 x 200 x 40	200 x 200 x 80	72
401	400 x 200 x 50	200 x 200 x 100	87

→ ONE-PIECE LANDING AREAS

These products provide a even landing surface and offer optimal user comfort. They are easy to transport and store thanks to the 4 carrying handles.



Ref.	Dim. in cm (LxWxTh)	Weight (kg)	Ref. cover only
411	300 x 200 x 40	52	421
412	300 x 200 x 50	63	422
413	400 x 200 x 40	69	423
414	400 x 200 x 50	83	424

Ref. 330 - TRANSPORT TROLLEY FOR MATS AND LANDING AREAS

Ideal for transporting learning modules and landing areas, these trolleys have 4 wheels, 2 of which feature a locking system for easier loading and storage. Carrying capacity: 300 kg. Dimensions: 200 x 70 cm (LxW).

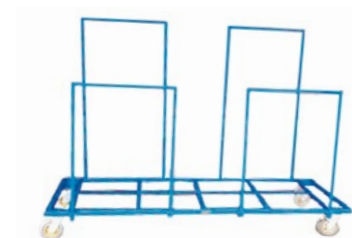

You will find our connectable learning modules on page 11.

PART 5

WRESTLING



→ FOLDING WRESTLING MATS FOR PHYSICAL EDUCATION & SPORT

Multi-use wrestling mats that are quick and easy to set up.

These fully covered concertina-folding polyethylene foam tracks with a density of 25 kg/m³ (2 x 1 m sections) are joined together by means of self-gripping strips.

Available in a number of versions, these wrestling mats are very convenient if equipment has to be set up for each session. The combat zone is bonded on the cover for greater resistance.

The cover is made of 1,000-denier PVC with a class M2 fire rating and is UV resistant.



Ref.	Dim. in cm (LxWxTh)	Contents	Ø of circle in m (inner/outer)
570	600 x 600 x 4	6 tracks, 6 x 1 m	4/5
571	600 x 600 x 5.5	6 tracks, 6 x 1 m	4/5
572	800 x 800 x 4	8 tracks, 8 x 1 m	6/7
573	800 x 800 x 5.5	8 tracks, 8 x 1 m	6/7
574	1000 x 1000 x 4	10 tracks, 10 x 1 m	8/9
575	1000 x 1000 x 5.5	10 tracks, 10 x 1 m	8/9

You will find our transport trolley Ref. 100 for your folding wrestling mats on page 7.

→ SCHOOL WRESTLING MAT WITH ROLL-UP TRACK BASE LAYER



FRONT: WRESTLING MARKINGS



REVERSE: JUDO MARKINGS

Versatile area for beginners in combat sports. These consist of roll-up tracks ❶ (see page 8) joined together by means of self-gripping strips and a 1000-denier PVC cover ❷ that is reversible (1 side for wrestling and 1 side for judo), easy-clean, phthalate-free and with a class M2 fire rating. Quick to assemble and disassemble. Two-toned cover.

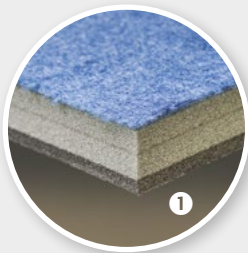

Roll-up track



Reversible cover

Ref.	Dim. in cm (LxWxTh)	Ref. cover only	Ø of circle in m (inner/outer)
540	600 x 600 x 3.5	545	5/6
541	800 x 800 x 3.5	546	6/8
542	1000 x 1,000 x 3.5	547	7/9

→ SCHOOL WRESTLING MAT WITH BARE FOAM BASE LAYER

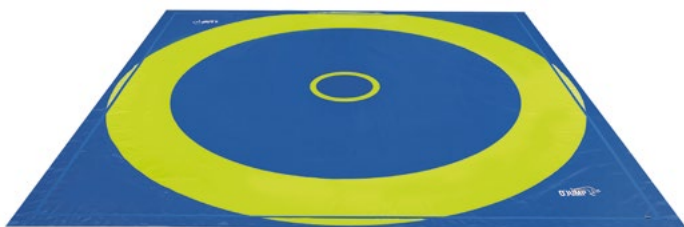

Ref.	Dim. in cm (LxWxTh)	Ref. cover only	Ø of circle in m (inner/outer)
580	600 x 600 x 4	545	5/6
582	600 x 600 x 5.5	545	5/6



Wrestling mats comprising a polyethylene foam base layer (density: 25 kg/m³) and a phthalate-free 1000-denier cover with class M2 fire rating attached by self-gripping strips to a flexible surrounding frame (roll-up track type, see page 9). Identical appearance to regulatory wrestling mats, but smaller in size. Quick to assemble and disassemble. Two-toned cover.

TRAINING WRESTLING MATS

Wrestling mats designed especially for training and available in 2 versions to meet the requirements of both sports associations and school establishments.



→ TRAINING WRESTLING MAT WITH 1-SURFACE COVER

Competition-type marking so that wrestlers can train under the same conditions as in competitions.

→ TRAINING WRESTLING MAT WITH REVERSIBLE 2-SURFACE COVER

Competition-type marking on the front and school-type marking with 4 zones on the reverse so that a number of children can train on the same surface in mini wrestling zones.

Circle diameters:

- **Cover 10 x 10 m:** inner 4 m/outer 4.9 m
- **Cover 12 x 12 m:** inner 4 m/outer 5 m

The two-tone cover is attached by self-gripping strips to a flexible surrounding frame (roll-up track type). It is made of 1,000-denier PVC with a class M2 fire rating and is UV resistant.

All the circles are bonded. These mats have a polyethylene foam base layer with density 25 kg/m³ for comfort. Quick and easy assembly and disassembly.

References available:

Dim. in cm (LxWxTh)	TRAINING WRESTLING MAT WITH 1-SURFACE COVER		TRAINING WRESTLING MAT WITH REVERSIBLE COVER		Ø OF CIRCLE IN M (INNER/ OUTER) FRONT
	Ref. complete mat	Ref. cover only	Ref. complete mat	Ref. cover only	
600 x 600 x 6	500	530	/	/	5/6
800 x 800 x 6	501	531	/	/	6/8
1000 x 1000 x 4	/	/	560	565	7/9
1000 x 1000 x 6	502	532	561	565	7/9
1200 x 1200 x 4	/	/	562	566	7/9
1200 x 1200 x 6	503	533	563	566	7/9



Please contact us if you prefer a cover finish with eyelets for attachment to the surrounding frame.

TRAINING WRESTLING MATS



↑ FRONT: COMPETITION MARKINGS

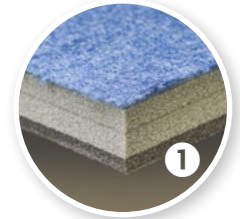

Surrounding frame



Base layer



Contents



↑ REVERSE: 4 COMBAT ZONES
(Available only on the reversible cover)

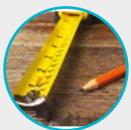

A specific requirement?

Your wrestling mats and covers can be made to measure to suit your needs and the layout of your room.

Thanks to our expertise, we can meet all your requests (colours, dimensions, your club logo, etc.).



Our team of technicians is at your service for installation of your products. Don't hesitate to contact us.

COMPETITION WRESTLING MATS

→ As the official supplier to many national and international competitions including the London 2012 Olympic Games, O'JUMP offers competition wrestling mats with the regulatory markings approved by UWW.



→ Designed for high-level competitions, O'JUMP wrestling mats in dual-density 6-cm thick foam offer a uniform and dynamic combat area that cushions falls by absorbing shock waves.

The three-colour cover with regulatory markings is attached by self-gripping strips to a flexible surrounding frame (roll-up track type). The cover is made of 1000-denier PVC; it has a class M2 fire rating and is UV resistant.

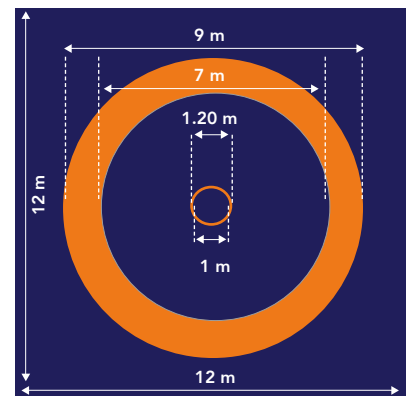

Ref.	Dim. in cm (LxWxTh)	Marking	Cover	Ø of circle in m (inner/outer)
520	600 x 600 x 6	Three colours	535	5/6
521	800 x 800 x 6	Three colours	536	6/8
522	1000 x 1000 x 6	Three colours	537	7/9
523	1200 x 1200 x 6	Three colours	534	7/9



UNITED WORLD
WRESTLING

PART 6

CLIMBING



CLIMBING LANDING SURFACE

Climbing requires a landing surface that is both stable for spotters and offers comfort in terms of cushioning any falls by climbers. O'JUMP has developed two types of mats specifically for indoor climbing and with safety in mind:

→ MATS FOR CLIMBING WALLS

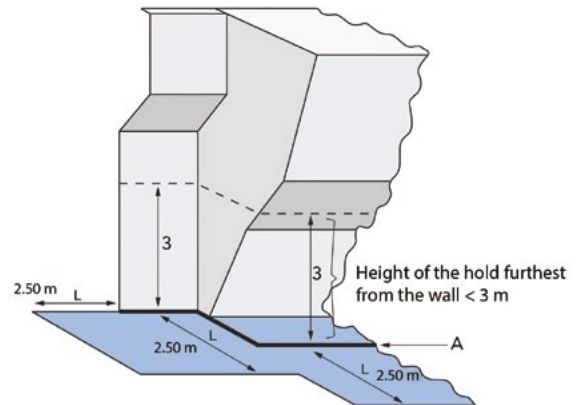

→ MATS FOR INDOOR BOULDERING ROOMS

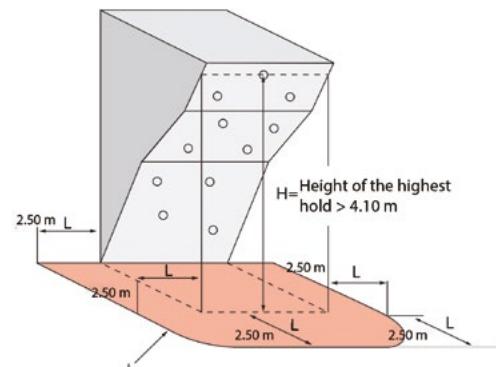

All our mats have a 5-year warranty and are compliant with standard NF-P90-311 or NF-P90-312. They are also supplied with a label indicating the date of manufacture and the relevant standard. Certificates of conformity can be supplied with your estimate or order on request.



Phthalate-Free

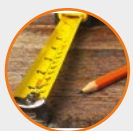

A specific requirement?

We create your climbing areas to order taking account of your requirements and constraints so that the landing area sits flush to the shape of the climbing wall in your school establishment or specialised club.

Personalised products for your made-to-measure project (dimensions, colours, your club logo, etc.)! Please don't hesitate to contact us for a design study.



→ MATS FOR CLIMBING WALLS

Foam mats specifically for Artificial Climbing Structures with a phthalate-free smooth 1000-denier PVC cover with class M2 fire rating. Their relative thinness prevents an overly high step for the spotter while also protecting the climber's head in the event of a fall. They are interconnected by means of removable self-gripping joining flaps, providing a perfect join. Closure on underside with zip fastening, anti-slip base and removable covers.

Colours available: 

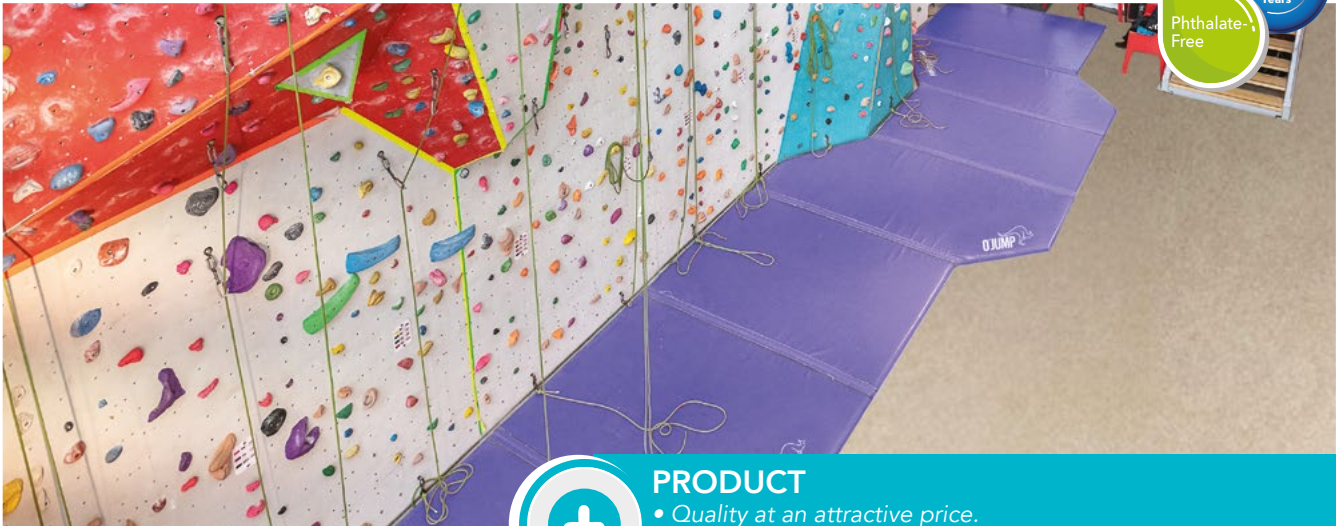

PRODUCT

- Quality at an attractive price.
- Firm mats for stable, impact-absorbing landings to help avoid injuries.

Compliant with standard NF-P90-312



MADE-TO-MEASURE MAT AREA FOR CLIMBING WALLS

Available in 2 thicknesses:

Ref.	Thicknesses	Technical specifications
725	5.5 cm	Single-density polyethylene foam
735	10 cm	Double density foam (mix of polyethylene and polyurethane)

Ref. 760

HOLDING STRAP

System for retaining mats in the vertical position with metal buckle. Ideal in school environments to free up floor space in multipurpose sports halls. L = 5 m. Per unit.

Colours available: 

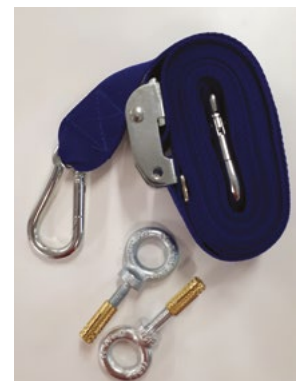

→ MATS FOR ROCK ROOMS

Mats specifically designed for use with equipment in rock rooms; they are made of polyurethane foam and have a phthalate-free smooth 1000-denier PVC cover with class M2 fire rating. They are interconnected by means of removable self-gripping joining flaps, 20 cm or 40 cm depending on the model, for a securely joined landing surface.

Colours available: 



Phthalate-Free



PRODUCT

All our covers are smooth for easy cleaning and do not attract chalk dust.

Compliant with standard NF-P90-311

MADE-TO-MEASURE MAT AREA FOR ROCK ROOM available in 2 thicknesses:

Ref.	Thicknesses	Technical specifications
707	30 cm	<p>Quality at an attractive price.</p> <p>Mat with or without self-gripping strips around the perimeter Double density polyurethane foam (23 kg/m³ and 30 kg/m³).</p>
717	40 cm	<p>For highly comfortable landings.</p> <p>Mat with or without self-gripping strips around the perimeter Single density polyurethane foam (23 kg/m³).</p>

→ OPTIONS AVAILABLE:

It is possible to add two options to your mat area to extend its lifespan and always preserve the internal foam in terms of reliability, safety and comfort. To benefit from these options, your mats must be equipped with self-gripping strips around the perimeter.

Option 1

Protective top-cover



Option 2

Overlay carpet

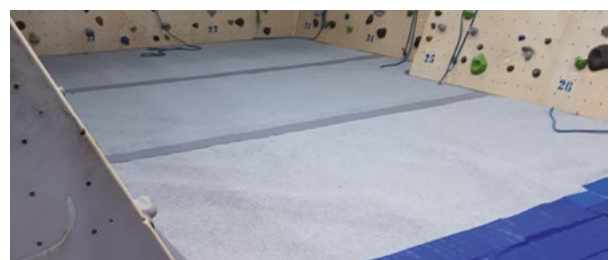

The overlay carpet is made of polyethylene foam covered with a needle punch carpet with Cfl-S1 fire rating (equivalent to M2). Simply vacuum to clean.



O'JUMP

PART 7

PROTECTIVE PADDING

O'JUMP

WALL PROTECTIVE PADDING

Our range of protective padding for walls is suitable for all wall types and protects users from risks and falls. These protective elements are ideal for public premises (shopping malls, schools, hospitals) and sport spaces (combat sports, gymnastics, team sports, etc.).



→ Ref. 820 REMOVABLE WALL PROTECTIVE PADDING

Mat made of 25 kg/m³ high density polyethylene foam with a 1000-denier PVC cover with class M2 fire rating ①. It is attached by means of a self-gripping strip system bonded or screwed onto the wall ②. Size: : 200 x 100 x 5.5 cm (LxWxTh)

Colours available:



→ FIXED WALL PROTECTIVE PADDING

Suitable for all types of flat surfaces. Bonded foam protective padding (density: 120 kg/m³) coated with imitation leather fabric with class M2 fire rating. Adhesive not included.

Colours available:

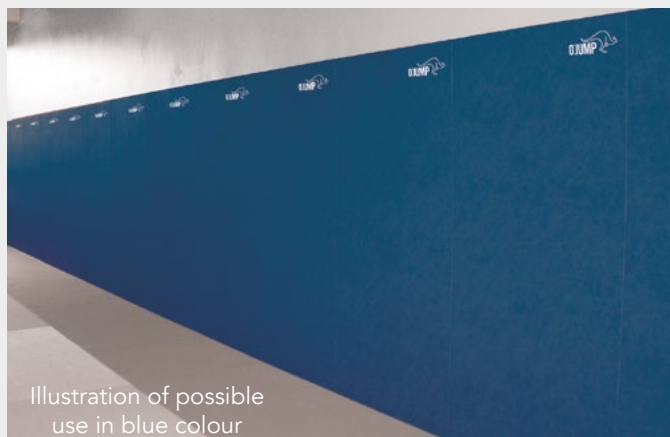

Illustration of possible use in blue colour



Wall protection can be cut to measure.

Ref. 810 - 200 x 100 x 2.5 cm (LxWxTh)

Ref. 815 - 150 x 100 x 2.5 cm (LxWxTh)

Anti-trip edging strip, please ask us.



For custom wall coverings, please contact us.



We recommend installing wall protective padding if the distance between the edge of the area or mat and the wall or obstacle is less than 1.50 m.

PROTECTIVE PADDING FOR POSTS

The protective padding covers both indoor and outdoor posts to make all your sports areas safer. Resistant to humidity and adverse weather. 10-cm thick polyurethane foam protective padding (density: 23 kg/m³) covered with 1000-denier PVC with a class M2 fire rating held in place by self-gripping joining flaps. Height: 2 m.



Colours available:

→ PROTECTIVE PADDING FOR SQUARE POSTS



Ref.	Description
840	Protective padding for 10x10 cm cross-section posts
841	Protective padding for 20x20 cm cross-section posts
842	Protective padding for 30x30 cm cross-section posts

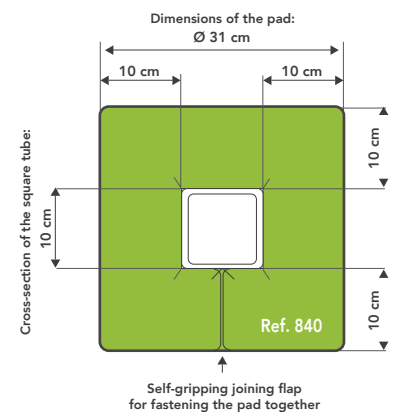

→ PROTECTIVE PADDING FOR "U" SHAPED POSTS



Self-gripping system

- a rigid strip to be attached to the wall (fixing method to be defined according to type of wall)
- a flexible strip on the protective pad

Ref.	Description
850	Protective padding for 36x17 cm cross-section girders
851	Protective padding for 36x18 cm cross-section girders
852	Protective padding for 36x20 cm cross-section girders

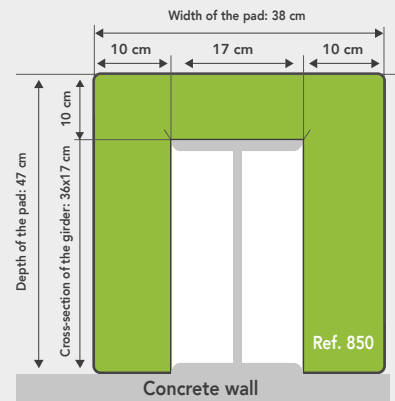

→ PROTECTIVE PADDING FOR CYLINDRICAL POSTS

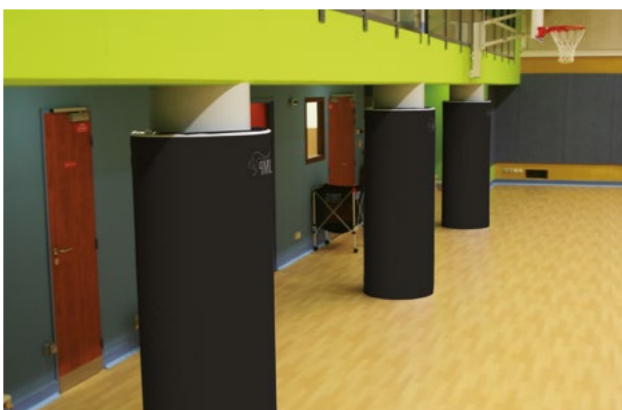

Ref.	Description
860	Protective padding for posts with \varnothing 10 cm
861	Protective padding for posts with \varnothing 20 cm
862	Protective padding for posts with \varnothing 25 cm

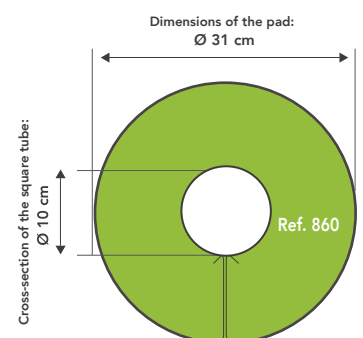

PROTECTIVE PADDING FOR POSTS

This protective padding is designed specifically for rugby, handball and volleyball. It covers exposed posts in these team sports providing complete player safety. Foam protective padding covered with a phthalate-free 1000-denier PVC cover with class M2 fire rating. Quick and easy to position using a self-gripping strip system.



Colours available:



→ PROTECTIVE PADDING FOR RUGBY POSTS

Protective padding made of 30 kg/m³ density polyurethane foam offering excellent impact absorption.

Set of 4 protective pads.

Ref. 831 - Square protective pads - Dim. 30 x 30 cm

Ref. 832 - Square protective pads - Dim. 50 x 50 cm



→ Ref. 870 PROTECTIVE PADDING FOR VOLLEYBALL POSTS

Bonded foam protective padding with density 120 kg/m³, also suitable for beach volleyball posts. Fastened with self-gripping tabs and a tension device which provides low net tension. Pair.

Size: : 200 x 15 x 2 cm (HxØxTh)



→ Ref. 835 PROTECTIVE PADDING FOR HANDBALL POSTS

Square protective padding made of 25 kg/m³ density polyethylene foam.

Set of 4 protective pads.

Size: : 200 x 4 cm (HxTh) - Section: 16 x 12 cm

PROTECTIVE PADDING FOR POSTS

• PERSONALISABLE - MADE-TO-MEASURE



All protective pads are available in a wide choice of colours and can be personalised. For variations or specific cut requirements, our design department draws up precise plans and recommends the solution best suited to your needs. Don't hesitate to consult us.

EXAMPLES OF CUSTOMISED PROTECTIVE PADDING:



Phthalate-Free



→ Ref. 800 CORNER PROTECTIVE PADDING

Corner protective padding makes all your indoor and outdoor sports areas safer. It enables you to set up safe and secure activities for children. It provides total protection for all corners and is suitable for various support frames. Resistant to temperature variations and humidity. Quick and easy to fit. Attached with adhesive or screws. Thickness: 4 cm. Per unit.

Size: : 150 x 19.5 x 10.5 cm (LxWxH)

Colours available:



A	
Asymmetric bars	20
B	
Balance beam.....	21
Blocks	17 & 22
Buck.....	22
C	
Competition wrestling mats	38
Connectable learning modules	11
Corner protective padding.....	47
Custom protective padding	47
Cylinders.....	14
D	
Dome.....	14
F	
Fixed wall protective padding.....	44
Foam modules.....	13 to 16
Folding gymnastics tracks	08
Folding mats for beginners	34
Folding mats.....	11
Freestyle training bars	30
H	
Half-cylinders.....	14
Half-hexagons	13
Hand-rails	20
Hexagons	13
High bar	24
L	
Landing areas for climbing	39 to 41
Landing areas	32
Landing mats	12
M	
Mats for climbing walls.....	41
Mats for bouldering walls.....	42
Mats for schools	06
Multicolour gymnastics areas	07
Multi-purpose mats	10
O	
Overlay carpet for climbing gym floor	42
P	
Parallel bars (low)	24
PE.....	19 to 24
Protective padding for handball posts	46
Protective padding for indoor and outdoor.....	45
Protective padding for rugby posts.....	46
Protective padding for volleyball posts.....	46
Protective padding	43 to 47
Protective top-cover for rock rooms.....	42
R	
Raised wedges	16
Removable wall protective padding.....	44
Reversible training wrestling mats.....	37
Roll-up gymnastics tracks	09
S	
Safety mats	10
School wrestling mats.....	35
Self-gripping strips	09
Shock-absorbent mats.....	06
Steps.....	15
T	
Training wrestling mats.....	36
Trampette.....	23
Transport trolleys.....	7 & 32
V	
Vaulting horses	16
W	
Wedges	15



The photos in this catalogue are non-contractual
and for illustration purposes only.

Photo credit: **O'Jump, Istock**

Diagrams: **O'Jump**

Design: **Césure**

Edition: **April 2021**

**View our General Terms and Conditions
of Sale on our website**

www.ojump.com

***Acknowledgments:** We would like to thank the Ninja Adventure Club (Villeurbanne & Toulouse) the Azium Climbing Club (Lyon) and the Mouscron Gymnastics Club (Belgium) for welcoming us to their gyms to take the photos in this catalogue.*



A GYMNOVA BRAND

CS 30056 - 45 RUE GASTON DE FLOTTE
13375 MARSEILLE CEDEX 12 - FRANCE

TEL. +33 (0)4 91 87 51 20
FAX: +33 (0)4 91 93 86 89

info@ojump.com
WWW.OJUMP.COM



une société d' **ABÉO** 